



THE SAXON NEWS

Volksblatt

Celebrating over 100 years of Saxon Fraternalism

Published by
The Alliance
of Transylvanian Saxons
Home Office: 5393 Pearl Road
Cleveland, Ohio 44129-1597
Tel: (440) 842-8442

ATS Founded in 1902

Friday, July 23, 2010

Issue 15

2010 HEIMATTAG COLORING CONTEST



The ATS Youth Activities Committee wishes to thank our members who entered the Heimattag Coloring Contest. We certainly enjoy seeing your beautiful work and the judges always have a difficult job choosing the best entries. Art kits were sent to the top winners and everyone received a coloring/activity book for entering the contest.

* Contests Top Winners *

Ages 3 – 4

Sofia K. Terlesky
Br. 22 Youngstown

Andrea Griffith
Br. 2 Erie

Ages 7 – 8

Sarah Lohse
Br. 2 Erie

Megan Schuster
Br. 4 Cleveland

Honorable Mention:

Ages 3 – 4

Ryan Arkwright, Br. 30 Youngstown
Thalia Fabian, Br. 22 Youngstown
Olivia Lang, Br. 27 New Castle
Jack Pallo, Br. 30 Youngstown
Samantha Penzone, Br. 17 Canton
Alexander Temple, Br. 1 Cleveland
Richard Turk, Br. 1 Cleveland

Ages 5 – 6

Brooke Bednarz, Br. 37 Detroit
Paige Deloy, Br. 9 Chicago
Makayla Dunford, Br. 2 Erie
Haven Estabrook, Br. 45 Ellwood City
Joelle Fabian, Br. 22 Youngstown
Macy McConville, Br. 4 Cleveland
Savannah Spack, Br. 19 Salem
Emma Ulrich, Br. 19 Salem
Sebastian Temple, Br. 1 Cleveland
George Turk, Br. 1 Cleveland
Julia Weihs, Br. 37 Detroit

Ages 5 – 6

Megan Goellner
Br. 2 Erie

Erika A. Miller
Br. 19 Salem (lives in Florida)

Ages 9 – 10

Dakota Hrabowy
Br. 30 Youngstown

Megan Arkwright
Br. 22 Youngstown

Ages 7 - 8

Aurora Estabrook, Br. 45 Ellwood City
Kaitlyn Griffith, Br. 2 Erie
Delaney Pallo, Br.22 Youngstown
Jenna Weihs, Br. 37 Detroit

Ages 9 - 10

Corrin Erskine, Br. 22 Youngstown
Johnah Hrabowy, Br. 22 Youngstown
Emma Goellner, Br. 2 Erie
Jenna Salmen, Br. 9 Chicago
Kathleen Schuster, Br. 4 Cleveland
Jessica Weihs, Br. 37 Detroit

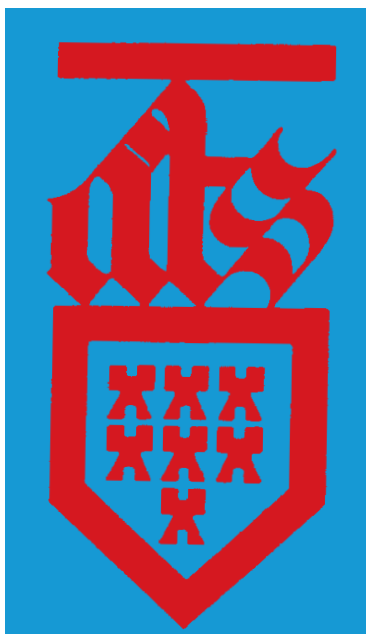

Be **A**CTIVE
Be **T**RUE
Be **S**TOLZ!

TIMELY - DO NOT DELAY
MAILED WEDNESDAY, July 21, 2010

Attention Postmaster: Send all Changes of Address to:
The Alliance of Transylvanian Saxons
5393 Pearl Road Cleveland, OH 44129-1597

PRESIDENT'S MESSAGE

By Thomas J. Manning
ATS Nat'l President



We certainly are enjoying a beautiful summer, and those of us with central air conditioning should not complain about the high temperatures and humidity. Several days ago I was watching the local weather report and the weatherman said the temperature was hovering near 90 degrees, with about the same amount of humidity. He then showed a picture of a very large snow drift from last winter. I guess that we can always find something to complain about if we try hard enough. I do find that I don't have to mow the lawn as much when the weather is this hot, and the tomatoes on our vines will ripen much sooner. There is nothing like the taste of a home grown tomato.

Recently, we were informed that George Bell, the former Director of the Gemischer Chor der Siebenbuerger Sachsen von Chicago, has passed away. George will be remembered for his dedicated service of German song. We send our sympathy and prayers to his family.

On a lighter note, I thought you might enjoy this little tidbit. A photographer for a national news magazine was assigned to get photos of a big forest fire. Smoke at the scene was too thick to get any good shots, so he called his home office to hire a plane. His editor assured him a plane will be waiting for him. As soon as he arrived at the small rural airport, the plane was warming up near the runway. He jumped in and yelled, "Let's go, let's go". The pilot swung the plane into the wind and soon they were in the air. "Fly over the other side of the fire and make three or four low passes." "Why", asked the pilot. "Because I'm going to take pictures. I'm a photographer and photographers take pictures." After a long pause the pilot said, "You mean you're not my instructor?"

Quote of the Day:

"A strong positive mental attitude will create more miracles than any wonder drug."

We don't understand entirely when positive thoughts impact our bodies in positive ways. We just know that they do. Research has shown that people who are sick improve more quickly when they have a positive attitude rather than a negative attitude and we all know the power of the placebo effect. A positive attitude by itself may not cure an illness, but at the very least it helps us cope better. If a positive attitude can help us when we are sick, how might it benefit us when we are not sick."

Take care until next time and may God bless the members of the ATS.

THANK YOU!!! CLEVELAND MUNDERFING HOST FAMILIES

On behalf of Cleveland Branch 1, many thanks go out to the following members and friends who opened their homes to accommodate our new friends from Munderfing

Erhard and Lisa Bell	Dieter and Christa Herbert
Jacob and Rosie Zimmer	Robert and Pam Bonnett
Greg and Anna Spangler	Michael Salmen
Martin Schuller/ Inge Schuster	Robert and Luitgard Wehner
Jim and Julie Weselok	Monica Weber /Marc Myers
Hanz and Barbara Hermann	Richard and Monika Gross
Adolf and Maria Fischer	Rob and Stephanie Hanek
Greg and Amy Moore	

I'm sure that if you would ask any of them about the experience, they would say that it was "priceless."

Hanz Hermann, Housing Coordinator

BRANCH 4 , CLEVELAND
by Joan Miller-Malue

The summer started off grand with a successful Heimattag that was held in Erie, Pa. that included the performances of the Cleveland Saxon Dance Group, Youngstown Culture Group, New Castle Eintracht-Männerchor, Erie Sachsen Gesang Verein, Kitchener Transylvania Club's Dancers and Choir, and special guest the Munderfing Blaskmusik and Tanzgruppe. We partied to wee hours of the night and have brought back a lot of great memories.

The Sachsenheim had a full house for the Munderfing Concert. It was a great night and the band's performance was outstanding. We wish to thank those Cleveland members and friends who housed members of the Munderfing group. The group was so grateful that every one of their members was hosted by a family in Cleveland. They truly appreciated your kindness and great hospitality! That is what this exchange program is all about.

Saxon Summer Camp has taken place this week and we are happy that five of Cleveland-West junior members were able to attend: Morgen Smoot, Bridget and Greta Schuster, Zachary and Jacob Botsch. I am sure they will have some great stories to tell their

families and friends.

ATS Family Day at Waldameer Park and Water World located in Erie, Pa will be held on Saturday, July 31st. Tickets are discounted for ATS members, \$10 and also discounted for non-members at \$17. We have a reserved pavilion and you can bring along your own picnic lunches. For those that do not want to ride on the amusement park rides or cool off at the water park, there is no charge. So this is a great event for the entire family, young or old. Bingo will be played at the pavilion at 4 pm. You are permitted to bring in alcoholic drinks at the pavilion, but cannot take drinks into the amusement or water park. Hope to see you there.

The Sachsenheim's Annual Sommerfest will be held on Saturday, August 21 starting at 5:00 pm. It will be a fun evening with plenty of homemade cooking and liquid refreshments, great entertainment by the Deutscher Musik Verein and the Cleveland Saxon Dance Group and genuine Saxon Gemütlichkeit. And we will have something for the children. Make sure to invite your friends.

Our next monthly meeting will be held on Monday, September 20th. So enjoy the rest of the summer.

BRANCH 5, LORAIN
By Elmer Schneider

Well here it is already the middle of July; where has the time gone so fast? Soon we will be seeing the snowflakes flying again.

Our next regular meeting will be on Saturday, August 7 at 8:00 p.m. at the American Slovak Club. Before the meeting we will once again meet at the Chris Restaurant for dinner which begins at 6:00 p.m. We ask everyone to please be on time.

We extend our sympathy to the family of Sister Wanda Sanders of Branch 11 who was living in Wadsworth, Ohio who passed away on July 6, 2010 at the age of 91. Wanda is survived by sons, Greg and Brent Sanders, four grandchildren and one great grandchild.

The time is drawing closer for our Branch Family Picnic which will be held on Sunday, August 22nd at the Pine Tree Reservation located on French Creek Road. We have Shelter #1 reserved from 1-8 p.m. As in the past Branch 5 will furnish the entrée, refreshments and table service while the ladies of Branch 11 will bring side dishes which have always been of great variety and good taste.

Please make your reservation as soon as possible by calling Brother Brian Gilles at 315-5214 to let him know how many are coming.

Members celebrating birthdays in July are Brothers Scott Kranstuber and Kyle Cassidy and Juvenile members Rachel Gibson, Kaily Hochevar and Lauryn Davis. We wish these members a very happy birthday and hope they will have many, more happy, healthy ones to come.

Just heard from Brian that the deadline for reservations is Wednesday, August 17th so mark that down and get your name in early.

Procrastination is like a credit card. It's a lot of fun until you get the bill.

Christopher Parker,
English actor, host

sounds great and is really enjoying Florida. She is also doing remarkably well after having major surgery.

Happy Birthday to Sisters Ida Binder, Patricia Brings Plenty, Dana Brown, Johanna Goohs, Eleanor Schuffert, Denise Weiler, and Virginia Wright.

If you or anyone you know is interested in purchasing a life insurance or annuity policy, please give me a call at 440-989-8180. I would be more than happy to sit down with you and discuss the many products offered by the ATS.

The next meeting will be September 4 at the American Slovak Club on Broadway. Meetings start at 8pm.

Alliance of Transylvanian Saxons
Home Office: 5393 Pearl Rd., Cleveland, Ohio 44129
Telephone: (440) 842-8442
E-mail: office@atsaxons.com Website: www.atsaxons.com

National Board of Directors

President -

Thomas J. Manning Br. 2 (814) 864-6072
1027 West 30th St., Erie, PA 16508

First Vice President -

Robert B. Cunningham III Br. 1 (216) 398-7520
9005 Memphis Villas Blvd., Brooklyn, OH 44144-2426

Second Vice President -

Joan Miller-Malue Br. 4 (216) 251-6036
17105 Hilliard Rd., Lakewood, OH 44107

Third Vice President -

John Boehm, Jr. Br. 30 (330) 821-5572
2416 Queensbury Rd. NE, Alliance, OH 44601

Secretary-

Monica M. Weber Br. 4 (440) 356-5936
19625 Riverwood Ave, Rocky River, OH 44116

Treasurer-

Denise Aeling Crawford Br. 8 (330) 821-5125
15970 Cenfield St. Alliance, OH 44601

Trustees-

Peter Karsti, II Br. 30 (330) 792-2281
4619 Canfield Rd., Canfield, OH 44406

Ronald Benedict Br. 25 (724) 667-7395
PO Box 25, Edinburg, PA 16116

Jacob F. Spor Br. 25 (724) 657-3773

2940 Plank Rd., New Castle PA 16105

Barbara Brayn Br 18 (330) 337-7487

1389 Brookview Dr., Salem OH 44460

Hanz G. Hermann Br. 1 (440) 892-0436

29076 Fall River Dr., Westlake OH 44145

Chief Medical Examiner-

Dr. David E. Schuller Br. 33 Cleveland

National Committee Appointees-

Helen E. Aeling Br. 8 Alliance (330) 862-2563

Elisabeth Weber Br. 4 Cleveland (216) 272-3504

Ingrid Weihs-Ferguson Br. 37 Detroit (586) 264-6136

Robert P. Vogt, Sr. Br. 19 Salem (330) 337-6357

Henry Holmes Br. 7 Farrell (724) 981-7130

BRANCH 11, LORAIN
By Monica Gilles

I hope everyone is enjoying his or her summer and warm weather. We are not having meetings during the summer. The next meeting will be September 4. However, there are activities planned during the summer I hope you plan to attend.

Join us for an afternoon of bowling at Black River Lanes located at 613 Oberlin-Elyria Road in Elyria. The date will be Saturday, August 7 starting at 2:00 PM. You can bowl as long as you would like or until they kick us out. The cost will be \$1.00 per game and \$2.00 for shoe rental, to be paid at the bowling alley. No reservations are required. Just show up and mention you are with the Saxon group.

The summer picnic will be Sunday, August 22 at French Creek Shelter #1. As in years past, the men's lodge will provide the main entrée, table settings, and beverages. The women's lodge was asked to supply the side dishes and desserts. Everyone is encouraged to attend and if you have a favorite activity to play, bring it along. There is a playground area near by for the kids. Cost of FREE for dues paying members and \$5.00 for non members and guests. Please contact Brother Brian Gilles at 440-315-5214 to make reservations. Deadline for reservations will be Wednesday, August 18.

We had a great turnout for the summer card party. Members and guests had an enjoyable time playing cards, socializing, and eating. The afternoon went quickly. Like the old saying, "Time flies when you're having FUN". Thanks to those who attended and supported this event, and to the committee for putting in their time and talents to organize and host the card party.

Saxon Summer Camp will be at Joseph Badger Meadow Camp is going on right now. This year, Chloe Zgola went to camp. I am sure she is enjoying herself while her parents and sister miss her.

The ATS Open Bowling Tournament will be in Merrillville this year the weekend of October 23-24. Look in the *Volksblatt* for more information. Let us start forming teams now and have a good showing from Lorain.

Sadly, I have to report the passing of one of our 50-year members, Wanda Sanders. Wanda had been a member of Branch 11 since 1947. She passed away on July 8. Her sons, Greg Sanders of Elyria and Brent Sanders of Mansfield, four grandchildren, one great grandchild, and siblings Lois Morrison and Evelyn Homonai survive Sister Sanders. Our deepest sympathy to her family and friends.

Josephine Schneider is recuperating nicely after carpal tunnel surgery. I spoke with Joan Goohs recently also. She

The Saxon News Volksblatt (ISSN 0894-1165), the official publication of the Alliance of Transylvanian Saxons, 5393 Pearl Road, Cleveland, Ohio 44129-1597, is published Bi-weekly.

Annual Subscription rate for non-ATS members
USA - \$15; Canada and Europe -\$50

Managing Editors HB Laser Communications,
PO Box 45198, Westlake, Ohio 44145.
"Periodicals Postage Paid" at Cleveland, Ohio.
Postmaster: Send address changes to the Saxon News
Volksblatt, 5393 Pearl Road, Cleveland, Ohio 44129-1597

SECRETARIES TAKE NOTICE:

**THE DEADLINE DATE FOR ARTICLES
IS FRIDAY - 12 NOON.**

You may either

**MAIL: PO BOX 45198,
Westlake, OH 44145,**

FAX: (440) 399-9339

E-MAIL: saxonvolksblatt@aol.com

Articles e-mailed will receive an e-mailed confirmation by Noon Saturday. If you did not receive confirmation, please give us a call.

Deadline Dates for articles:

DEADLINE	ISSUE
FRIDAY, JULY 30, 2010	FRIDAY, AUGUST 6, 2010
FRIDAY, AUGUST 13, 2010	FRIDAY, AUGUST 20, 2010
FRIDAY, AUGUST 27, 2010	FRIDAY, SEPTEMBER 3, 2010

Please have your articles in by 12 Noon.

Did you miss the deadline?

Have you emailed your article past 12 noon?

Please call Hanz or Barb Hermann at (440) 892-0436.

ALLIANCE OF TRANSYLVANIAN SAXONS

ANNUAL OPEN HANDICAP BOWLING TOURNAMENT

Stardust Lanes Merrillville IN

October 23-24th, 2010

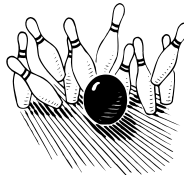

ENTRY FEE	TEAM	DOUBLES	SINGLES	ALL EVENTS
PRIZE	\$25.00	\$10.00	\$ 5.00	\$2.00
BOWLING	\$50.00	\$20.00	\$10.00	
EXPENSES	\$10.00	\$ 4.00	\$ 2.00	
TOTAL	\$85.00	\$34.00	\$17.00	\$2.00

TEAM NAME _____

BRANCH # _____ CITY _____

Name address and phone number of person submitting entry:

Name _____ Phone# _____

Address _____

City, State, Zip _____

SATURDAY, OCTOBER 23, 2010

SINGLES NOON	DOUBLES 2:30 PM
NAME	NAME
1. _____	1. _____
2. _____	2. _____
3. _____	3. _____
4. _____	4. _____
5. _____	5. _____
6. _____	6. _____

ALL EVENTS	ALL EVENTS
1. _____	1. _____
2. _____	2. _____
3. _____	3. _____

SUNDAY, OCTOBER 24, 2010 10:00 AM

TEAM EVENT	ATS#	ABC/WIBC	AVERAGE
NAME	(MUST)	SANCTION#	
1. _____			
2. _____			
3. _____			
4. _____			
5. _____			

Deadline for entries is October 9, 2010. NO ENTRIES AFTER THAT DATE.

All fees MUST accompany this form. No refunds after October 15, 2010.

Send all entries to Jimm Smith 2420 West 61st PI Merrillville IN 46410

Tel : (219) 887-5375

Team Event	_____	@ \$85.00	_____
Doubles	_____	@ \$34.00	_____
Singles	_____	@ \$17.00	_____
All Events	_____	@ \$2.00	_____
Non-Bowler Sunday Banquet Reservations (CBS)	_____	@ \$24.00	_____
Bowler Sunday Banquet Reservations (Beef and chicken)	_____	@ \$10.00	_____
TOTAL ENCLOSED	_____		_____

BOWLING TOURNAMENT HOTELS

- Lee's Inn
6201 Opportunity Ln, Merrillville, IN 219-942-8555
\$99.00 + 12% tax
- Comfort Inn
1915 Mississippi St, Hobart, IN 219-947-7677
\$79.00 + 12% tax
- Radisson Hotel At Star Plaza
800 E 81st Ave, Merrillville, IN 219-769-6311
\$99.00 + 12% tax
- Fairfield Inn
8275 Georgia St, Merrillville, IN 219-736-0500
\$109.00 + 12% tax
- Red Roof Inn
8290 Georgia St, Merrillville, IN 219-738-2430
\$73.99 + 12% tax
- Hampton Inn
8353 Georgia St, Merrillville, IN 219-736-7600
\$129.00 + 12% tax
- Holiday Inn Express
8375 Georgia St, Merrillville, IN 219-795-9500
\$109.00 + 12% tax
- La Quinta Inn
8210 Louisiana St, Merrillville, IN 219-738-2870
\$56.00/double bed + 12% tax \$63.00/king bed + 12% tax
- Knights Inn
8250 Louisiana St, Merrillville, IN 219-736-5100
\$59.89 + 12% tax
- Super 8 Motel
8300 Louisiana St, Merrillville, IN 219-736-8383
\$59.99 + 12% tax
- Economy Inn of America
8275 Louisiana St, Merrillville, IN 219-736-2355
\$49.00 + 12% tax
- Country Inn and Suites
8311 Ohio St, Merrillville, IN 219-736-1300
\$89.00 + 11% tax
- Motel 6
8290 Louisiana St, Merrillville, IN 219-738-2701
\$49.00 + 12% tax
- Days Inn
1350 E 83rd Ave, Merrillville, IN 219-736-5252
\$59.00/single bed + 12% tax \$64.00/double bed + 12% tax

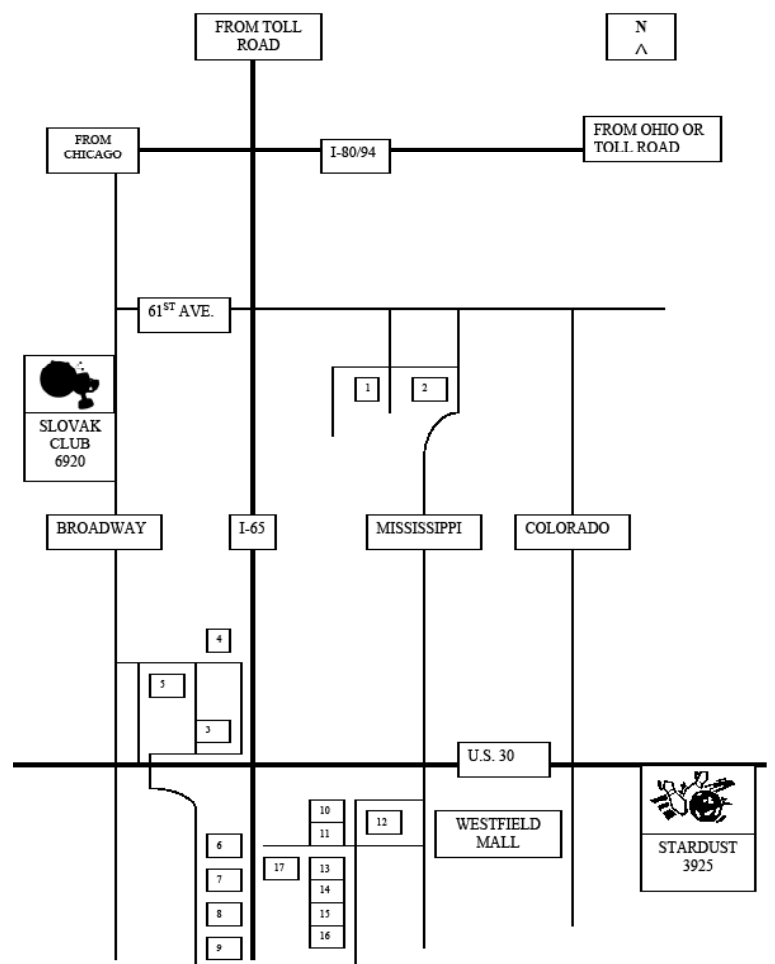

Test your knowledge of bowling (facts) with these entertaining trivia questions

- When a bowler is able to knock down all ten bowling pins with one throw, he or she is said to have executed
 - A spare
 - A split
 - A perfect throw
 - A strike
 - None of the above
- Standardized rules for modern bowling were first established in
 - 1895
 - 1915
 - 1935
 - 1955
 - 1975

Answers: 1) D 2) A

FRATERNAL CALENDAR

NATIONAL EVENTS

2010

July 24, 2010

ATS Golf Outing
Host Branch 25 New Castle
Mohawk Trail Golf Course

July 31, 2010

ATS Family Day
Waldameer Park/Water World Erie PA
Deep River Water Park Crown Point IN

September 10 - 12

Teen Weekend
Salem Saxon Club Grounds
Ages 13 - 19

September 25, 2010

Siebenbürger Sachsen Sängerbund Convention
Host Eintracht Saxonia Sachsenchor Cleveland

October 23-24, 2010

ATS Open Bowling Tournament
Stardust II Lanes - Merrillville, Indiana

LOCAL EVENTS

July 25, 2010

Youngstown Saxon Day Picnic

July 29, 2010

Salem Br. 19 Officer's Mtg. 7:30 p.m.

July 31, 2010

Salem Br. 18/19 Peanut Night 8:00 p.m. - ?

August 1, 2010

Merrillville Br. 26 Meeting

August 2, 2010

Salem Br. 19 Trustees Audit 6:30 p.m.
Salem Br. 19 Meeting 7:30 p.m.

August 4, 2010

Salem Saxon Retirees 11:30 a.m.

August 7, 2010

New Castle Br. 25 Jimmy Buffet Night @ Grounds
Lorain Br. 5 & 11 Family Bowling 2 pm
Black River Lanes Elyria

Aug 8, 2010

Youngstown Branch 22 and Branch 30 meeting

August 9, 2010

Salem Br. 18 Meeting 7:30 p.m.

August 12, 2010

Youngstown Retirees Meet

August 13, 2010

Salem Joint Social Dinner 6:30 p.m.

August 15, 2010

New Castle Br. 25 Members Picnic @ Grounds

August 21, 2010

Youngstown Couples Bocce Banquet
Salem Breakfast 7:00 - 10:00 a.m.
Cleveland Br. 1 Sommerfest

August 22, 2010

Lorain Br. 5 & 11 Summer Picnic 1 - 8 pm
French Creek Shelter #1

August 26, 2010

Youngstown Ladies Bocce Banquet

August 27, 2010

New Castle Br. 25 Night at the Races @ Grounds

August 28, 2010

Salem Peanut Night 8:00 p.m. - ?

September 1, 2010

Salem Saxon Retirees 11:30 a.m.

September 5, 2010

Merrillville Br. 26 Meeting
New Castle Branch 25 Bocce Tournament @
Grounds (1 PM - ?, Steak dinner to follow)

September 6, 2010

New Castle Br. 25 Monday Night Drawing @Grounds
Youngstown Saxon Club closed

September 9, 2010

Salem Br. 19 Officer's Mtg. 7:30 p.m.
Youngstown Retirees Meet

September 10, 2010

Salem Joint Social Dinner 6:30 p.m.
Youngstown Men's Bocce Banquet

September 11, 2010

Merrillville Br. 26 Balmoral Race Track outing
Youngstown 250/300 Club Dinner

September 12, 2010

Youngstown Branch 30 and Branch 22 meet

September 13, 2010

Salem Br. 18/19 Joint Mtg. 7:30 p.m.

September 18, 2010

Youngstown Golf League Banquet

BRANCH 2, ERIE

By Lee Wolfe

Hi.... We did not have a meeting in July as we held our annual picnic. We were blessed with good weather, cloudy but with no thunderstorm as predicted. The meal provided by DeVecchio's was very good and the cake for dessert was delicious. The members had fun playing the Corn Hole game, and the winners were Sal and Helen Frontino and Bob Wingerter and Joanne Kurczewski; they all received Club dinner gift certificates for their win. We all enjoyed bingo, buying tips, the taking chances on the board game and the Chinese Auction. The board game was won by Lee Wolfe, Judy Wagner and Lois Barthelmes who split the winnings. The Club's dinner gift certificate was won by Donald Pietrowski and the 50/50 by Hilda Borgia. I think Hilda would rather have won Val Pinczewski's Polish Sweet Bread. Char Manning brought an unusual plant which intrigued everyone. Her number was called but she graciously said to pull another ticket and it was won by her sister-in-law, Liz Manning, so the plant stays in the family. Every year Marge Pinczewski brings a plant which she starts from a slip and it gets huge and every year I try to win it to no avail. A big thank you to all of the members who donated an item for the Chinese Auction which has been a big hit every year. We also send a Thank you to all the members who make our picnic so enjoyable, namely Val and Art Pinczewski, Tom and Liz Manning, Dick and Judy Wagner, Marge Pinczewski, Char Manning, George Cook, Sal Frontino and Ray Borgia. All of these members pitch in and help and it's much appreciated.

At the picnic, we held a special ceremony for John and Mary Ann Hess who, due to ill health, resigned their positions as officers. They were presented with a monetary gift and a bouquet of red roses. John and Mary Ann were dedicated members of our Branch and the ATS, not only as officers but they were always willing to help with anything that had to be done. They have our sincere thanks for their service and we will miss them a lot. We love you, John and Mary Ann, God bless you and you will always be in our prayers.

Liz Manning was presented with a bouquet of colorful daisies for all the hard work she put in to the planning of the Heimattag which was a year and a half in the making.

The Heimattag hosted by our Branch was an outstanding huge success enjoyed by all who attended the events. On Friday night, the social at the Siebenbuerger Club was a wonderful time, especially for the young people who were part of the cultural group performers and members of the Munderfing Band from Austria. The DJ engaged played great dance music and he had a big screen showing the performers of the recordings. The "young ones"

danced up a storm and sang with a lot of pep and enthusiasm. We "old ones" watched and sighed "Oh to be young again!" On Saturday morning a bus took our guests from Munderfing to our beach and sandwiches were provided. At the Social we had sandwiches, salads and an array of desserts donated by Branch 2 members.

Liz Manning asked me to insert the following in this column: *"Tom and Liz Manning send a big thank you to the following members who sent their generous dessert donations for our Friday evening Heimattag celebration on June 25th. It was a very successful event with 237 persons in attendance and they all enjoyed your wonderful baked goods. Thanks for all that you did when we really needed your help. Marge Pinczewski, Pat Batts, Donnalee Morschhauser, Loretta Marshall, Mary Nemenz, Judy Wagner, Vince Leone, Florence Martin, Helen Frontino, Mary Cook, Joanne Kurczewski, Karl Gaber, Frank Sims, Dorothy Floros, Char Manning, Myrell Wellman, Lee Wolfe and Val Pinczewski. Special thanks to Val Pinczewski and Lee Wolfe who manned the reservation table at the Ambassador Banquet Hall on Saturday evening and to Val and Art Pinczewski who did so on Sunday. Your efforts are much appreciated. We hope that everyone that attended any of the Heimattag events had an enjoyable time."* I would like to add to the above, thank you Liz for all your hard work.

Saturday night of the Heimattag at the Ambassador was a grand affair. The employees of the Ambassador did us proud with the table setups, quickness, politeness and friendliness of the servers. They were all super! The entertainment of the cultural dancers from Kitchener, Canada and Austria and the bands from Youngstown, Cleveland and Austria were most enjoyable. It was a nice evening well spent.

I was unable to attend the Sunday event as our family was celebrating a delayed Father's Day at our son's home. From all reports it was an inspiring and another enjoyable time.

We would like to send a special thank you to Joan Miller-Malue from the Home Office who also did an amazing time of work planning this in conjunction with Liz. As was mentioned it took a year and a half to get this whole affair planned so you can imagine the time and effort that had to go into it. Having seen how well planned this was and how everything fell into place I can only say, you did a bang up job. Thank you so much. I have not mentioned our President Tom Manning because he does not take any credit but gives credit to everyone else. So, thank you Tom we know you helped to make the Heimattag a success, too. We know it was one of your dreams to have the Heimattag here in Erie, so you

must feel proud and happy that it turned out so well. (We wonder how many times you sang "Ein Prosit".)

Please note, everyone: there will be a meeting in August.

Our next affair will be our October supper/business meeting which will be held on Tuesday, October 12th at 2:30 p.m. Gosh, I hate to think about October, this summer is going by to darn fast as is.

Belated happy birthday greetings to Sara Addressi who celebrated on March 27th. Sarah says I neglect to put her name in but I will remember from now on.

A very happy birthday to all of our August babies some of whom are: Corey McLaughlin, William J. Wood, Sara Comi, Lilliana Griffith, Marge Pinczewski, Joanne Kurczewski, Lee Wolfe, Richard Wagner, Sr., Karl Gaber, Jake Randolph, Fritz Randolph, Sarah Lohse, Helen Mason, Maureen Nicholson, Louis Hesch, Thomas J. Manning (the Prez), Joseph Marshall and Justin Griffith.

A very happy anniversary to all of our August couples some of whom are: William and Eileen Reed, William and Donnalee Morschauer, Richard and Leona Wolfe, Lester and Margaret Carr and Joseph and Esther Neilsen.

The ATS Family Day Picnic will be held at our Waldameer Park in Erie on Saturday, July 31st. A picnic pavillion named "Pine Valley" has been reserved for ATS members. Bring your own picnic basket. Further details were in the last *Volksblatt*.

See you at the August 10th meeting Tuesday at 2:30 p.m. Stay "cool" everyone.. take care and enjoy the rest of the summer because it's gone too soon.

BRANCH 10, COLUMBUS

By Hilda Kautz

We're back in Ohio again. There were 24 of us who spent a few days on the river boat "Twilight", gliding along the very muddy Mississippi River. The weather cooperated, the food was excellent and more than ample. We had a variety of entertainment, and, of course, a casino waiting in Dubuque to relieve us of our money. It was a fun time.

BUT, I blew it again!! The Mississippi trip interfered and I forgot the *Volksblatt* deadline. I am so sorry that I am late wishing all the July birthday celebrants another year of good luck and good health. As they say, "better late than never," so please forgive me. All our best wishes to John Fleischer (7), Rose Inman (12), Evelyn Roth (15), Regina Kellner (20), Alfred Allert (21), and Mike Lassel (22). Belated Happy Anniversary wishes to George and Sara Alzner who celebrated 54 years on July 7.

Hope everyone remembers our regular meeting on July 19th at the Germania.

BRANCH 30, YOUNGSTOWN
By Tom Fizet

There is still time to purchase your 300 Club tickets. There are drawings yet in July and August for monthly winners. The Banquet will be on Saturday, September 11th in the Ballroom. The dinner will be your choice of Prime Rib (a la Saxon club) or Chicken. Don't forget the prizes. If you need tickets or information, call Rick Lieb at 330-792-1350; if no answer leave a message.

It has been a few weeks since the wonderful Mundering Band and Dance Group visited us in Youngstown. Thanks to all for the great success of the concert evening and the hosting of our guests. Particular thanks goes to Marty, Michelle and Kiki Eberth, Walter Benesch, the families Karsti, Boehm, Dick, and Krauss for hosting some guests and to Branch 22, the Culture Group and to all who attended the Concert.

Branch 30 offers their condolences to Jim Buchman, officer of Branch 30 (and coffee maker) and to his family, on the death of his wife Louise on July 2, 2010. She was a long time member of Branch 22. Jim and Louise were married for 57 years.

Youngstown Branch 22 and Branch 30 will meet on Sunday August 8, 2010 at 2:30 PM. On meeting day Sunday the Kitchen will be open for dinner. Come and enjoy with friends. Each Sunday the kitchen is open for a Breakfast Brunch.

Don't forget the Saxon Day Picnic July 25, 2010 at the club. Look elsewhere in the *Volksblatt*

for details. Contact Neil (Red) Stertzbach or Bill Karako if you want to play a game of softball with the Canadians; game begins at 11:00 AM. The picnic will begin at 1:00 PM. Pete and Mike Jr. can always use some help setting up during the picnic and cleaning up. Some of us may need to go on a diet until the Speck Fry comes along on September 19th. Branch 22 has their Chinese Auction on the same day in the Ballroom. Keep this date open.

The Branch 30 Pork Dinner will be on September 26th in the Ballroom. Jim Mauch says that help is always needed; contact him or the office.

We welcome Eric Cahalin into Branch 30 as a new member.

Head Trustee Ernie Roth is not up to par after knee surgery. Rich Maurer is doing fine after Cataract surgery. Send a card or give them a call. Everyone is always welcome to come to the Sunday Dance, held in the Ballroom on Sundays at 6:00 PM to meet new people and old friends, enjoy dancing and some refreshments.

On Saturday, July 24th, Girard High School graduating class of 1945 will have a 65 year reunion celebration in the Lower Lounge. We have visitors from Las Vegas, Oscar and Sally, members of the class and the ATS. Marge and Don Betts of Boardman, also members of the ATS, enjoy reading the *Volksblatt*. It is always good to see them and exchange stories.

So goes the News.

BRANCH 34, CLEVELAND EAST
by Arline Krestel-Suts

Summer is in full swing, and I hope everyone is out having fun. Just writing a short note to remind members of Branch 33 and 34 of some details and events.

First, a reminder that our annual summer picnic is scheduled for Sunday August 1 at Penitentiary Glen in Kirtland. We have the Picnic Pavilion reserved from 12 noon til 8pm; games start at 2pm; the catered dinner by Dino's will be served at 4pm. Cost is \$5 for members, \$10 for guests, and children under 12 are free. Remember to bring your own place settings and cutlery. Branch 34 ladies whose last names begin with L to Z are asked to bring a dessert to share. Drinks are free courtesy of Branch 33. Reservations need to be made with Fred and Ingeborg Krestel at (440) 639-1775.

I want to send best wishes to several members who have been ill: I am happy to report that George Schneider is doing well after having brain surgery. Mike Foisel needs lots of prayers sent his way after suffering several set-backs due to complications after his hip replacement. Mary Ann Guip is recuperating after a fall and damaging her knee; unfortunately she had to cut her vacation cruise short as well.

Kathy Zink called and sent her greetings to everyone, so I want to say Hello right back to her and hope you are well. Marie Fekter always keeps in contact with many members and is staying up-beat and optimistic. Also, keep Ronnie Maurer and Hermine Prall in your thoughts and prayers.

The ATS Open Bowling Tournament is October 23-24 in Merrillville Indiana. The sign-up and registration form has been in the *Volksblatt*. October really isn't that far away. Merrillville will make for a nice weekend away, so I encourage many of you to sign up for bowling and partying in Indiana! I'm not sure if Mary Ann Guip will be up to bowling for awhile because of her injury, so any members who would like to join our Ladies East team, please call Ingeborg Krestel if you are interested (440)639-1775. We would really like to have additional bowlers! It's only 8 sessions, about once a month, and so much fun!

Again, a reminder that there will be no meeting in August; our next meeting will be the second Wednesday in September at St. John's Lutheran Church in Highland Hts.

Hope to see many of you at the Picnic!



We remember our Sisters and Brothers who have departed this life in recent days. Our sincere sympathy is extended to the members of the bereaved families.

Joan M. Miller
Age 75

Died: June 13, 2010
Branch 4, Cleveland OH

Margaret L. Downer
Age 81

Died: June 24, 2010
Branch 22, Youngstown OH

Louise A. Buchman
Age 78

Died: July 2, 2010
Branch 22, Youngstown OH

Wanda E. Sanders
Age 91

Died: July 8, 2010
Branch 11, Lorain OH

ASK ...

ASK YOUR DEPUTY HOW
A CERTIFICATE OF
MEMBERSHIP IN THE ATS
CAN HELP YOU TO SAVE!

BRANCH 22, YOUNGSTOWN
By Rosemarie Kascher

Sometimes we get so caught up in every day responsibilities, that we forget to thank those who serve us so magnificently in our ATS offices, the ATS officers and Hanz and Barb with the *Volksblatt*. Having recently attended both Convention and Heimattag, I'm in awe of how well both of these events were managed with dignity, humor and as a people we stand for. Our special thanks go to Tom Manning and his lovely partner, Liz Manning.

Heimattag had particular meaning to me personally as the two tables with children, (thanks Joanie!) were connected. In both cases the fathers wanted their children to learn about the Saxon heritage of their mothers. The one father, Navy, came from Washington D.C. to attend a Heimattag with his family and the father from Philadelphia came, though seriously ill, to bring his family again to the Heimattag. Great grandmas too.

Branch 22 lost one of our finest members, Louise Buchman. Louise was one of our most loyal and hardworking officers over the years. Our sympathy goes to her family and the families of Margaret Downer and Carolyn

Kukura.

A thinking of you went to Tillie Stefanik with anniversaries to Margaret Whitacres in June and Virginia Williams, Regina Teutsch, Lisa Marucci in July with Darlene Nischwitz and Bob still celebrating their 50th wedding anniversary for the whole month of July. Birthdays are from June for Erna Weber, Michelle Eberth, Joan Raiger and Marge Teutsch. In July birthdays being celebrated are Barb Wertz, Kay Ring, Corine Kampman, Min Haner, Christine Simon and Fran Hinerman. August third is for our president, Bonnie Baker. Congratulations!

Our only fundraiser for the Branch 22 Scholarship is September 19th, the Chinese Auction, so please put it on your calendar and consider donating new items or cash donations. Realize that these scholarships are for adults as well as for high school graduates if you qualify, so give it a try.

August 4th is the next Officers' meeting and the next Branch 22 general meeting is August 8th. Our Saxon Day Picnic is July 25th from 1-6 p.m.; it's a time of fun and good food, so come join us!

ATS offers your insurance, fraternal benefits, and fellowship
Invite your relatives and friends to join us.

Call your local Deputy for full information on all our fraternal plans.

Br. 1 Cleveland
Robert Cunningham III
(216) 398-7520

Br. 2 Erie
Tom Manning
(814) 864-6072

Br. 3 Alliance
Denise Aeling Crawford
(330) 821-5125
dcrawfordcpa@yahoo.com
Helen Aeling
(330) 862-2563
HHA658@aol.com

Br. 4 Cleveland
Joan Miller-Malue
(216) 251-6036
Monica Weber
(440) 356-5936

Br. 5 Lorain
Monica Gilles
440-989-8180
gillemo76@hotmail.com

Br. 7 Farrell
Henry Holmes
(724) 981-7130
Bertha Chec
(724) 342-3139
Betty Jane Krafft
(724) 347-7935

Br. 8 Alliance
Denise Aeling Crawford
(330) 821-5125
dcrawfordcpa@yahoo.com
Helen Aeling
(330) 862-2563

Br. 9 Chicago

Br. 10 Columbus
Hilda Kautz
(614) 235-7661
rkautz@wideopenwest.com

Br. 11 Lorain
Monica Gilles
440-989-8180
gillemo76@hotmail.com

Br. 14 & 17 Canton
Helen Aeling
(330) 862-2563
HHA658@aol.com

Br. 18 Salem
Helen Aeling
(330) 862-2563
HHA658@aol.com
Barbara Brayn
(330) 337-7487
babrayn@sbcglobal.net

Br. 19 Salem
Helen Aeling
(330) 862-2563
HHA658@aol.com
Barbara Brayn
(330) 337-7487
babrayn@sbcglobal.net

Br. 22 Youngstown
Sofia B. Froom
(330) 652-9269

Br. 25 New Castle
Paul Hartfelder
(724) 652-5106
Ronald L. Benedict
(724) 667-7395

Br. 26 Merrillville
Randall Floyd
(219) 942-3494

Br. 27 New Castle
Marie A. Benedict
(724) 667-7395
bckskinbnny@verizon.net
Edith Hartfelder
(724) 652-5106
gach@access995.com

Br. 29 Monaca
Terri Munroe
(724) 774-7094
Carol A. Crudden
(724) 775-0260

Br. 30 Youngstown
Roger Fotiuk
(330) 792-0034
James Mauch
(330) 792-8484

Br. 32 & 45 Ellwood City
Sara Mullin
(724) 758-4764

Br. 33 Cleveland
Dolf Litschel
(440) 358-1184

Br. 34 Cleveland
Ema Litschel
(440) 358-1184

Br. 37 Detroit
Karin Weihs (517) 426-1059
or (623) 933-3550 AZ
Sam Klein, Jr.
(586) 677-6664
George Schemmel, Sr.
(586) 791-8135

Br. 40 Merrillville
Randall Floyd
(219) 942-3494

SALEM SAXON SCHOLARSHIP WINNERS



Pictured are left to right: Joseph Schlueter, Emily McIntosh, Rachel Fritzman and Julia Billingsley

BRANCH 18, SALEM
By Barbara Brayn

The Salem Saxon Scholarships were awarded at the Branch 18 and 19 joint social on Friday July 9. This was the 25th year of awarding scholarships and we gave checks in the amount of \$1000 each to four students. Scholarship fund trustee and president, Sam McKinney, presented the awards to Rachel Fritzman, Joseph Schlueter, Emily McIntosh, and Julia Billingsley. Rachel Fritzman is a graduate of Salem High School and the daughter of Mike and Patty Fritzman. She plans to attend John Carroll University. Joseph Schlueter is a graduate of West Branch High School and the son of Frederick and Lori Schlueter. He plans to attend Franciscan University of Steubenville. Emily McIntosh is a graduate of United High School and the daughter of Theresa McIntosh. She plans to attend Mount Union College. Julia Billingsley is a graduate of Sebring McKinley High School and the daughter of Kevin and

Tracy Billingsley. She plans to attend the University of Toledo. Rachel Fritzman also received the \$400 Donzella Herman Scholarship from the A.T.S. and Branch 18 president Marilyn McNutt presented her with her certificate. The recipients and their families joined the members for dinner following the presentation of the scholarships. Congratulations to these students and we wish them much success in their future. Thanks to Kate Oesch for preparing the main course and to all the members for the delicious side dishes they provided. Thanks also to Marilyn and to Flo Spack for setting up and helping in the kitchen, and to all those who helped clean up and wash dishes. Donations can be made to the scholarship in memory of a loved one or in honor of the 25th year of the fund and may be mailed to Art Maroscher, treasurer, at P.O. Box 720, Salem OH 44460.

NOTES OF THANKS

Additional Thank-You note from Scholarship Winner:

I would like to take this opportunity to thank you again for the Victor Deptner Memorial Scholarship. This scholarship helps me finance my education and continues to help me accomplish my goals at Purdue University. I completed my first year at Purdue in May and plan on returning in the fall to pursue a major in industrial engineering. Once again, thank you for this scholarship, as it will help me throughout my education.

Sincerely,
Jennifer Zemola

TIME FOR AN UPDATE?

If your family benefit status has changed during the last year please let us know:

ATS HOME OFFICE
(440) 842-8442
office@atsaxons.com



BRANCH 33, CLEVELAND EAST
By Jeff Krestel

August is fast approaching, so just a quick reminder of the annual picnic, Sunday, August 1st at the Penitentiary Glenn, located at 8668 Kirtland-Chardon Rd. in Kirtland, Ohio. My parents will be in Germany. Oh well, that leaves more fun for the rest of us. In case you were unable to get your money in, we can still sell tickets at the event. Cost is \$5.00 for members of Branch 33 and 34, \$10.00 for guests. Money will be used for prizes. Bring your own plates, utensils, and napkins. Our reservation begins at noon; games will start about 2:00, and dinner will be served at about 4:30. Dinner will be catered by Dino's.

Please keep Brother Mike Foisel in your thoughts. He is at Fairview Park's Grace Hospital, in long-term care. We would also like to say hello, and send thoughts to Brother Charles Keefer, and former Branch VP, Brother Ed Lautner.

Branch President George T. Schneider is recovering extremely well from his surgery. He has a wonderful sense of humor, and he can still proudly recite all 50 states, and the state capitals, in alphabetical order, and reverse order! I lost a bet with him!

The Fall Dinner-Dance will be on Sunday September 12th, from 1 to 5 pm. This year, the event will be held at "The Kirtlander," which is located on Route 306 in Kirtland, Ohio. The address is 9270 Chillicothe Road. It is about 3 to 4 miles South of I-90, just past Kirtland High School, and on the same side of the road.

Our next meeting is Wednesday, September 8th, at 7:30 pm, at St. John's Lutheran Church on Ford Road, in Highland Heights. There will be a party tray before the meeting.

If anyone wishes to contact me, you can e-mail me at jfawes@hotmail.com, or call me at (440) 376-5223. Let me know if there is something that you would like for me to include in the *Volksblatt*. See you at the picnic!

ST. THOMAS CHURCH PICNIC
AUGUST 29, 2010

The annual church picnic of St. Thomas Ev. Lutheran Church will be held Sunday, August 29. Worship begins at 10:30 a.m. at Lenau Park in Olmsted Township (We will NOT meet at the church.) Great food will be available at moderate prices, or bring your own picnic lunch. Our Bratwurst sandwiches "are worth the trip, wherever you are!" All are welcome — Bring a friend!



Branch 11 Lorain invites you to come out and "strike" up some fun! Join us for a Bowling Outing
Saturday, August 7, 2010

- Who:** Branch 11 & 5 members, families and friends
- What:** A fun-filled afternoon of bowling
- When:** Saturday, August 7, 2010, 2:00 pm - 6 pm
- Where:** Black River Lanes, 613 Oberlin-Elyria Rd., Elyria Ohio, Phone: 440-458-5144
- Cost:** \$1.00 a game; \$2.00 shoe rental. To be paid at the bowling alley the day of the outing.
- Additional Details:**
 - This promises to be a great opportunity for fun and fellowship!
 - Snack bar will be open at the bowling alley.
 - Family members and friends are certainly invited to come.
 - No reservations required. Just show up and mention you are with the Saxon group!



How to give and receive a compliment

Basics first: Be sincere and don't make the compliment too big or too small.

Be specific. Don't say you're good at your job, say it was a great report.

Show impact. Tell how the person positively affected you.

If you receive a compliment, just say thank you. Don't make a self-deprecating remark or feel you have to give a compliment in return.

- We like to get compliments from fellow workers and the boss. Men need compliments at home because they may not get many on the job. A compliment from a stranger is welcome if the person has no hidden agenda.
- Remember that people hear what they want to hear or expect to hear. If they are feeling good about themselves, they will like

a compliment. If they are feeling insecure or have self-doubt, they could read the wrong thing into what you are saying.

Be careful. If you say a guy looks handsome today, he might wonder how you think about him otherwise. Instead, say his sweater is handsome. Sometimes loved ones and friends have trouble hearing what we are saying.

* Go ahead and praise yourself if no one is giving a compliment you merit. Appreciate your new outfit or a job well done.

BRANCH 17, CANTON
By Jeanne Kirsch

Hot enough for you?? Are we going to complain about snow next winter?

Well, as you know we have been on vacation the month of July so our next meeting will be August 8th as well as our annual picnic. The meeting starts at 2:00 p.m. and eats at 3:00 p.m. We would like reservations by August 2nd and you can call me at 492-2856. If I don't answer, please leave a message. If you have difficulty contacting me you can also phone Mary Rowinsky at 478-9333 she also takes messages.

Now there have been a few members missing (AND you know who you are.)

Let's see who had a birthday in July. On the 7th it was Mary Perrott, on the 28th it was Dorothy Hayes and for August on the 12th it's Minnie Krach. Wishing you all nothing but good things!

Thought for the day: Difficulties are no match for determination! See you on the 8th.

LORAIN
BRANCH 5 AND 11
SUMMER FAMILY PICNIC

PICNIC

WHEN: AUGUST 22, 2010
WHERE: FRENCH CREEK SHELTER #1
WHAT TIME: 1PM - DUSK

THE MEN WILL PROVIDE THE MAIN ENTRÉE, TABLEWARE, AND BEVERAGES.
THE LADIES WILL PROVIDE DELICIOUS SIDE DISHES.

RSVP TO BRIAN GILLES AT (440) 315-5214
by AUGUST 18

48. Heimattag der Siebenbürger Sachsen aus Nordamerika

In der Stadt Erie, gelegen am Erie-See im nordamerikanischen Staat Pennsylvania, fand vom 25. bis 27. Juni der 48. Heimattag der Siebenbürger Sachsen aus Übersee statt. Ausrichter des Treffens, das in jährlichem Turnus wechselweise in den USA und Kanada veranstaltet wird, war der Zentralverband der Siebenbürger Sachsen in den USA, die Alliance of Transylvanian Saxons (ATS), die mehr als 10 000 ATS-Mitglieder vertritt. Der Heimattag, als „das großartigste sächsische Wochenende des Jahres“ gepriesen („The Grandest Saxon Weekend of the Year“), wurde am Freitag im Siebenbürger Club eingeleitet. Rund 350 Gäste genossen an den beiden folgenden Tagen im Ballsaal des Ambassador's Banquet Center die Festakte mit künstlerischen Darbietungen und vielen jugendlichen Trachtenträgern. Der Verband der Siebenbürger Sachsen in Deutschland e.V. war durch die stellvertretende Bundesvorsitzende Doris Hutter vertreten.

Der Bundesvorsitzende der Landsmannschaft der Siebenbürger Sachsen in Kanada, John Werner, würdigte in seiner Festrede die enge Verbundenheit seiner Landsmannschaft mit der ATS. Die gemeinsamen Kulturveranstaltungen wie der Heimattag in Dinkelsbühl und die Föderationsjugendlager vermittelten in erster Linie das „Gefühl der Zugehörigkeit zu unserer Gemeinschaft“. Thomas Manning, Präsident der ATS, bekräftigte die Solidarität mit den hilfsbedürftigen Landsleuten in Siebenbürgen.

Vor der offiziellen Eröffnung am Samstagnachmittag trafen sich die Würdenträger der Landsmannschaften und Verbände der Siebenbürger Sachsen zu einem Begrüßungscocktail. Nach dem feierlichen Einzug in den Ballsaal wurden mit allen Gästen des Heimattages und begleitet von der Youngstown Brass Band unter der Leitung von John Krauss die kanadische und amerikanische Hymne sowie das Siebenbürgenlied gesungen. Nach dem Festessen folgten die Grüße von ATS-Präsident Thomas Manning, ATS-Vizepräsident Robert B. Cunningham, von John Penteker, Vizepräsident der Landsmannschaft in Kanada, Doris Hutter, Stellvertretende Bundesvorsitzende des Verbandes in Deutschland, und Martin Voggenberger, Bürgermeister von Munderfing (Österreich).

Mit sehr anmutigen, schwungvollen Volkstänzen erfreuten die Kitchener Transylvania Dancers aus Kanada und die Siebenbürgische Tanzgruppe aus Munderfing unter der Leitung von Horst Raiger das begeisterte Publikum. Die Siebenbürger Blasmusik Munderfing unter der Leitung von Phillip Harant rundete den Abend mit flotter Blasmusik ab und lud zum Tanzen ein. Gute Stimmung herrschte bis nach Mitternacht und ging im privaten Kreise der jüngeren Generation bis in die Morgenstunden weiter, wobei auch deutsche Lieder gesungen wurden.

Der Sonntag begann mit einem Gottesdienst, dessen Festpredigt Rev. Horst Hoyer von der Immanuel Lutheran Church in Cleveland in Englisch und Deutsch hielt. Die musikalische Umrahmung gestalteten



Aufmarsch der Trachtenträger im Ballsaal des Ambassador's Banquet Center. Foto: Doris Hutter

stimmigewaltig der Eintracht Männerchor aus New Castle unter der Leitung von Danual Forsberg und die Munderfing Kapelle, die gleich zu Beginn „Ein feste Burg ist unser Gott“ anstimmte.

„Sie vergaßen ihre Wurzeln nicht“

Der traditionelle Trachtenaufmarsch, der die Kundgebung einleitete, stellt ein beachtenswertes Bekenntnis der überwiegend jugendlichen Teilnehmer zur Tradition ihrer Vorfahren dar. „Ich denke am Heimattag immer an meine Großeltern John und Katharina Balthes, die zu Beginn des 20. Jahrhunderts als Teenager in die USA immigrierten“, sagte ATS-Präsident Tom Manning in seiner Festrede. „Sie hatten es schwer in der Fremde. Als sie sich ein neues Leben aufbauten, vergaßen sie ihre Wurzeln nicht, sie pflegten die Werte der Siebenbürger Sachsen und lehrten uns, stolz auf unsere Herkunft zu sein.“ Harte Arbeit und ehrliche Glaubensgrundsätze hätten den Alltag geprägt und seien weitergegeben worden. Es liege an uns, dieses Erbe ebenfalls an die junge Generation weiterzugeben. Manning erinnerte daran, dass die ATS vor 108 Jahren gegründet wurde. „Mit ihrer Hilfe entstanden, als Bekenntnis zu unseren Wurzeln, Kirchen, Clubs, Sing- und Tanzgruppen sowie Blaskapellen, in denen viele fröhliche Stunden erlebt wurden, so dass viele schöne Erinnerungen daran geknüpft werden.“ Allerdings dürften wir beim Feiern die nicht vergessen, die in Siebenbürgen

unserer Hilfe bedürfen. Damit übergab Tom Manning im Auftrag der ATS und mehrerer Spender einen Scheck über umgerechnet rund 12 400 Euro an Doris Hutter für das Sozialwerk der Siebenbürger Sachsen in Deutschland.

Der Bundesvorsitzende der Landsmannschaft der Siebenbürger Sachsen in Kanada, John Werner, ging in seiner Festrede auf die enge Verbundenheit seiner Landsmannschaft mit der ATS ein. „Das Wichtigste, was wir von unseren gemeinsamen Kulturveranstaltungen mitnehmen, ist das Gefühl der Zugehörigkeit zu unserer Gemeinschaft. Dazu tragen der Heimattag in Dinkelsbühl und



Ehrgäste auf dem Podium beim festlichen Bankett, von links: Martin Voggenberger, Ingrid und Doris Hutter, John und Helgard Werner, Thomas und Liz Manning. Foto: Wilhelm Schenker

stellvertretende Bundesvorsitzende erwähnte die guten Beziehungen des Verbandes der Siebenbürger Sachsen in Deutschland zur rumänischen Regierung, die sich auch auf die in Siebenbürgen lebenden Sachsen positiv auswirken würden. Den Frauen ausdrücklich für ihren großen Anteil an der Pflege der Bräuche und Trachten dankend, schloss sie im Einklang mit den Siebenbürger Sachsen in Herzogenaurach, wo Gerhard Berner am gleichen Tag beim dortigen Kronenfest Grüße aus Erie verkündete. Hutter überbrachte Grüße vom Kronenfest und zitierte aus der Kronenrede: „Wir danken Gott, dass er die Saat/ bis hierher reifen lassen hat,/ und bitten, dass er weiter wacht,/ die Sonne uns gewogen lacht,/ dass sanft der Regen niederfällt/ und Frieden einkehrt in die Welt,/ damit recht unbeschwert und frei/das Arbeiten und Feiern sei./ So wie es unsre Ahnen machten,/ feiern wir heut in unsren Trachten“.

Beschwingtes

Kulturprogramm

Es folgten die kulturellen Darbietungen der schwungvollen Tanzgruppen Cleveland Saxon Dance Group und Youngstown Culture Group sowie Gesang des Eintracht Männerchors aus New Castle und des Chors des Transylvania Clubs Kitchener unter der Leitung von Ian Clark. Nach dem Mittagessen stieg der Deutsche Musikverein Cleveland unter der Leitung von Fred Ziwich mit einem Vuvuzela-Konzert ins Programm ein (nachdem verkündet worden war, dass

Deutschland England mit 4:1 geschlagen habe) und erfreute danach mit Blasmusik zum Tanzen. Erfreulicherweise trat auch der Erie Siebenbürgisch-Sächsische Gesangsverein unter der Leitung von Joan Miller auf.

Der Deutsch-Kanadische Sängerbund vergibt Ehrennadeln an Mitglieder, die 50 Jahre lang in Chören gesungen haben. Der Präsident des Deutsch-Kanadischen Sängerbundes verleiht diese Ehrungen normalerweise bei kanadischen Sängerevents. Der Chor des Transylvania Clubs konnte dieses Jahr jedoch nicht am Sängerevent teilnehmen, da er zum Heimattag nach Erie fuhr. Daher erhielt der Chorpräsident des Transylvania Clubs eine Ausnahmegenehmigung, diese Ehrung am Heimattag in Erie vorzunehmen. Geehrt wurden Rosie Frim, Grete Giebat, Wilma Gorbach, Emmi Hensel, Käthie Lowrick, Käthie Paulini, Mini Rau und Martin Schelling.

Ein weiterer Höhepunkt des Heimattages war das gemeinsame Tanzen. Ein wunderbarer Anblick, da überwiegend Jugendliche aufmarschierten. Unvergessliche Stunden gemeinsamen Feierns wurden gekrönt von vielen jungen Menschen, die in schönen Trachten ein Stück Kultur weiter tragen. Ebenfalls in Tracht waren am Sonntag auch die beiden Präsidenten Tom Manning und John Werner mit Ehefrau Helgard sowie Monica Weber aus Cle-

Fortsetzung auf Seite 8

Grüße vom Kronenfest in Herzogenaurach

Doris Hutter hatte am Vortag die Grüße der Siebenbürger Sachsen in Deutschland überbracht und hob nun in ihrer Festrede die Bedeutung der Siebenbürgischen Zeitung hervor, durch die die Siebenbürger Sachsen und ihre Nachkommen weltweit die Möglichkeit hätten, miteinander in Verbindung zu bleiben. Durch sie erfährte man z.B., welche Gruppen und Veranstaltungen es in Übersee gibt, dass es Orte gibt, wo das Bespritzen am Ostersonntag noch gepflegt wird, dass Wettbewerbe wie im Sauerkrautessen oder Zwiebelschalen stattfinden. Mitreißende Ideen würden der Gemeinschaft Halt und frische Impulse geben. Die



Thomas Manning übergibt den Scheck für das Sozialwerk an Doris Hutter.

HEIMATTAG

Fortsetzung von Seite 7

veland/Ohio, die Vorsitzende des ATS-Kulturkomitees, in deren Händen die Gesamtorganisation des Heimattages lag. Sie war vor Ort tatkräftig von Liz Manning unterstützt worden und führte am Heimattag charmant und sicher durch das Programm.

Von Monica und Liz Weber betreut, war übrigens am Samstagvormittag für die Gastgruppen aus Österreich und für die Gäste aus Deutschland ein Ausflug auf eine Halbinsel im Erie-See organisiert worden, wo diese baden und sich am Strand auch sportlich, z. B. mit Ballspielen vergnügen konnten. Die Siebenbürgische Kapelle aus Munderfing, begleitet von Bürgermeister Martin Voggenberger, war Tage davor zusammen mit der Siebenbürgischen Tanzgruppe Munderfing in Kitchener/Kanada aufgetreten und sollte nach dem Heimattag weiter zu den Siebenbürger Sachsen nach Cleveland/Ohio reisen. Die in Kitchener geknüpften freundschaftlichen Kontakte waren nicht zu übersehen.

Herzlich war die Begrüßung zwischen den aus den USA, Kanada, Österreich und Deutschland angereisten Gästen schon am Freitag gewesen, als ungezwungen und fröhlich der Kameradschaftsabend im großen Saal des Siebenbürger Clubs stattfand. Man sang und tanzte. Das Kuchenbuffet bot köstliche selbst gebackene Spezialitäten nach siebenbürgischen Rezepten, wie Nussstriezel und gefüllte Kipfel. Das Bekenntnis der Siebenbürger Sachsen zu ihren Wurzeln wird in Übersee auch sprachlich deutlich: Bestimmte Worte - Heimattag, Tracht, Kameradschaft, Siebenbürgen, Gemütlichkeit oder Landsleute - werden beim Sprechen in Englisch liebevoll deutsch gesagt.

Seitens des Verbandes der Siebenbürger Sachsen in Deutschland danke ich unseren Landsleuten aus den USA für ihre herzliche Gastfreundschaft sowie allen Teilnehmern für die Gestaltung dieses Gemeinschaftserlebnisses, das durch seine noch so siebenbürgisch-sächsische Prägung und Solidarität mit den Sachsen, ganz besonders in Siebenbürgen, sehr beeindruckt hat.

Doris Hutter

SBZ Online 17. Juli 2010



Bundesvorsitzender in Stiftungsrat gewählt

Berlin - Der Deutsche Bundestag hat die Mitglieder des Rates der „Stiftung Flucht, Vertreibung, Versöhnung“ gewählt. Auf der Liste, die am 8. Juli mit den Stimmen von Union und FDP angenommen wurde, stand auch der Bundesvorsitzende des Verbandes der Siebenbürger Sachsen in Deutschland, Dr. Bernd Fabritius. Mit der Wahl der Stiftungsratsmitglieder ist die Novellierung des Stiftungsgesetzes umgesetzt. So werden künftig die Mitglieder des Stiftungsrates nicht mehr durch die Bundesregierung bestellt, sondern vom Deutschen Bundestag gewählt. Hieraus erwächst dem Stiftungsrat eine höhere Legitimation. Die unter dem Dach des Deutschen Historischen Museums verbleibende „Stiftung Flucht, Vertreibung, Versöhnung“ ist nun voll handlungsfähig und kann die inhaltliche Arbeit intensivieren.

Die geplante Vertriebenen-Ausstellung im Berliner Deutschlandhaus soll 3000 Quadratmeter umfassen. Gemäß der im Stiftungsgesetz festgeschriebenen Zielsetzung soll die Erinnerung und das Gedenken an Flucht und Vertreibung im 20. Jahrhundert im historischen Kontext des Zweiten Weltkrieges und der nationalsozialistischen Expansions- und Vernichtungspolitik und ihrer Folgen wachgehalten, die junge Generation an das Thema herangeführt und die aktuelle europäische Dimension dieser Thematik verdeutlicht werden. Die Dokumentationsausstellung soll zur gemeinsamen Aufarbeitung der Geschichte und zur Versöhnung beitragen.

Die Präsidentin des Bundes der Vertriebenen, Erika Steinbach, begrüßte die Entscheidung des Deutschen Bundestages. Damit sei das angestrebte Ziel, die Funktions- und Arbeitsfähigkeit der „Stiftung Flucht, Vertreibung, Versöhnung“ zu optimieren, erreicht. Diese werde „von der Verbreiterung der Sachkompetenz insbesondere durch die Vertreter des Bundes der Vertriebenen profitieren“. Steinbach hatte nach jahrelangem Streit über die Stiftung im Februar dieses Jahres auf einen Sitz im Stiftungsrat verzichtet. Dergefundenen Kompromisslösung zufolge wurden dem Bund der Vertriebenen sechs statt bis dahin drei Sitze im Gremium eingeräumt. Die Gesamtzahl der Sitze wurde von 13 auf 21 erhöht.

Baustein für Versöhnung und Verständigung im Europa des 21. Jahrhunderts

Der Bundesvorsitzende Dr. Bernd Fabritius erklärte gegenüber der Siebenbürgischen Zeitung, dass die Erweiterung des Stiftungsrates die Vielschichtigkeit der Schicksale innerhalb der Gemeinschaft der Heimatvertriebenen, Aussiedler und Spätaussiedler besser abbilde. Über diese demokratische Wahl durch den Deutschen Bundestag habe er sich sehr gefreut. Die so geschaffene Legitimation, „für die kommenden fünf Jahre in diesem sehr hochrangig und quer durch das gesamte Betroffenen- und Parteienspektrum besetzten Gremium mitzuwirken“, wolle er dafür nutzen, „auch das Schicksal der Deutschen aus Rumänien unter dem Aspekt des Kriegsfolgeschicksals in das Blickfeld der umfassenden

Stiftungstätigkeit zu rücken“.

Darüber hinaus gehe es ihm darum, „das erforderliche Erinnern, Mahnen, Aufarbeiten und Versöhnen in eine zukunftsorientierte Richtung zu bringen, die dem europäischen Gedanken eines friedlichen Zusammenlebens am nächsten kommt“, betonte Dr. Fabritius. „Auf dem Boden geschichtlicher Wahrheithaftigkeit“ könne besonders die junge Generation dieser Schicksalsgemeinschaft, zu der er sich in diesem Kontext noch zähle, „einen wichtigen Baustein gerade zur Versöhnung und zum Verständnis beitragen“. „Emotionale Betroffenheit“, wie sie „bei der Erlebnisgeneration der ersten Nachkriegsstunden verständlicher Weise noch vorhanden“ sei, wirke mitunter „trübend auf den Blick für sich bietende Möglichkeiten des Brückenbaus im Europa des 21. Jahrhunderts“. Diese Möglichkeiten wolle er verstärkt nutzen.

In der jüngsten Entwicklung der Beziehungen der Siebenbürger Sachsen zum Herkunftsland Rumänien sieht der Bundesvorsitzende die Verbandsstrategie bestätigt. Gerade auch Siebenbürger Sachsen sei es in den letzten Jahren gelungen, „erfolgreich gute Beziehungen zum Herkunftsland aufzubauen und diese im Sinne gegenseitiger Verständigung zu nutzen“. Und dies trotz weitreichender kollektiver Repressionen in der Vergangenheit als Folge des Zweiten Weltkrieges. Allem voran erinnerte Fabritius an „die Russlanddeportation aller erwerbsfähigen Frauen und Männer sowie die Enteignungen des Kollektiv- und des Individualvermögens, die unserer Gemeinschaft die wirtschaftliche Existenzgrundlage in Siebenbürgen raubte“. Durch Rumäniens Beitritt zur Europäischen Union seien „Chancen für eine erneute verstärkte Präsenz in unserem Herkunftsgebiet geschaffen“ worden. Diese gelte es noch stärker zu nutzen, zumal Rumänien durch seine Regierung erklärt habe, die Siebenbürger Sachsen zu vermissen. „Das ist doch der beste Beweis dafür, dass die Strategie unseres Verbandes die richtige ist und sich als Beispiel empfiehlt. Etwas davon möchte ich auch in meine Arbeit im Stiftungsrat einbringen.“, bekräftigte der Bundesvorsitzende gegenüber dieser Zeitung.

Christian Schoger
SBZ Online
13. Juli 2010

Heimatkirche wirkt beratend in der Föderation der Siebenbürger Sachsen mit

Hermannstadt – Das Landeskonsistorium hat in seiner Sitzung vom 11. Juni den Bischof der Evangelischen Kirche A. B. als Vertreter mit beratender Stimme im Föderationsrat der Föderation der Siebenbürger Sachsen ernannt. Bei Verhinderung kann der Bischof durch den Landeskirchenkurator oder den Bischofsvikar vertreten werden.

Damit werden „das Gespräch und der Austausch sowie konkrete Kooperationen auch auf diesem Wege gepflegt und vertieft“, heißt es in einem Schreiben von Bischof D. Dr. Christoph Klein und Hauptanwalt Friedrich Gunesch an die Föderation.

Beim Heimattag der Siebenbürger Sachsen am 30. Mai 2009 in Dinkelsbühl wurde ein neues Statut der Föderation angenommen und die Heimatkirche als neues Mitglied eingeladen. Der weltweite Dachverband wurde 1983/1984 von den Landsmannschaften in Deutschland, Österreich, den USA und Kanada gegründet, 1993 trat das Siebenbürgenforum bei.

Sb

SBZ Online 8. Juli 2010



Emma Gundisch

Wojjelied

*Schlof, me Kaingd,
me läiwet Kaingd,
noch bäst te froi vi Sorjen.
Schlof, me Kaingd,
de Motter saingt,
schlof bäs än de Morjen.*

*Silang ech kon,
geläiwet Kaingd,
wäll ech dich troi bewachen,
datt tau noch froi vi Lid
uch Saingd
des Morjest kost erwachen.*

*Driem sess, me Kaingd,
vi Froid uch Glück,
noch bäst te jo bei mir;
äm Däonkeln äs noch
de Geschäck,
wot wird et brengen dii'?*

*Uch dir wird se
bestämmt de Wih,
deng Diel i Lid uch Kämmer
und nichen Motter
wird dro mih
bewachen denge Schlämmer.*

Vor einiger Zeit hat Frau Elisabeth Kulcsar ein Wiegenlied in Heltauer Mundart eingeschickt, das ihre Großmutter Emma Gündisch Kindern und Enkelkindern oft vorgesungen hat. Den Text, so versicherte Frau Kulcsar, habe ihre Groß-

CHURCHES



St. Peter's German and Saxon Lutheran Church

11423 Chicago Rd.
Warren, Michigan 48093
(586) 979-3850
stpeters_church@sbcglobal.net
www.stpeterswarren.or

10:00 Bilingual Service
Nursery School
Coffee following service.
Bible Study, Senior Circle,
Sunday School, Church
Choir, Bell Choir

St. Thomas Evangelical Lutheran Church

9509 Lake Avenue
Cleveland, OH
(216) 961-4870

Rev. Dick Williams
Pastor
Cell (330) 524-1718

9:00 a.m. German Service
2nd Sunday of the month
Pastor Susanne Carter

10:00 a.m. Coffee Hour
Adult Bible Study

11:00 a.m. English Worship

Daily Devotion:
www.EarlyWord.org

St. John's Lutheran Church

1000 Ford Road
Highland Hts., Ohio
(440) 449-1334

Rev. Paul Stork
Pastor

10:00 Worship Service
10:00 Sunday School

mutter selbst geschrieben. Die Melodie stamme vom ehemaligen Stolzenburger Rektor Schmidt, sei inzwischen aber leider verloren gegangen.

Emma Gündisch, 1881-1964, lebte in Heltau, war Hausfrau, Mutter von sieben Kindern und schaffte im wollverarbeitenden Familienbetrieb mit. Ihr Sohn Richard Gündisch war langjährig Lehrer und Organist in Stolzenburg.

Eine Eigenart der Heltauer Mundart ist das *i* statt des sonst üblichen *u*, z. B. *froi vi Sorjen* (frei von Sorgen), statt: *frå vu Sorjen*, oder *deng Diel i Lied uch Kämmer* (dein Teil an Leid und Kummer), statt: *deng Diel u Lied uch Kommer*.

Das Gedicht „Wajjelied“ ist unser Gruß an alle Mütter, denen wir unsern Dank bezeugen können oder die wir in liebender Erinnerung bewahren!

Hanni Markel
und Bernddieter Schobel

SALEM SAXON RETIREES By Sue Fritzman

The Salem Retirees enjoyed grilled pork chops prepared by the committee when they met July 7th with 44 in attendance. President Lois Whitacre opened the meeting with the Retirees reciting *The Pledge of Allegiance*, followed by Bill Hiltbrand presenting the invocation. The Secretary's Minutes were read and approved. Katy Lederle gave the Treasurer's Report with no old business to report. A motion was made by Frank Diehl and seconded by Marian Whipkey to lower the rent of club to \$50, which was passed.

Marilyn McNutt announced that Br. 18 and 19 would have a display table at the Salem International Festival to be held on Aug. 13th and 14th. She also asked for help with the monthly breakfasts, which are held the 3rd Saturday of each month. Stop out - the serving is plentiful and opened to the public.

Bill Hiltbrand read another lengthy list of members who are ill.

Members celebrating birthdays and anniversaries for July were acknowledged with an announcement made that Hazel Tibball will be having a special 90th birthday celebration.

Happy Birthday to our August birthday members! Ray Denny - 1, Walter Combs - 3, Norma Byers - 11, Doc Whitacre - 18, Marianne Vogt - 18, Anneliese Rothbrust - 18, Mary Helen Hoprich - 21, Gerti Sebo - 23, Albert Linder - 23, Mary Kekel - 24, Regina Bruckner - 24, Mary Ann Roth - 25, Betty Wagner - 26, Charles Vona - 28, Rudy Maroscher - 29, Katy Lederle - 30, Ralph Cook - 31.

Congratulations to our August Anniversary Couples! Bob and Janet Kekel, 52 years; Henrietta and Walter Combs, 20th, 15 years; Ike and Hilda Spack, 31st, 64 years.

Congratulations to all the Saxon Scholarship recipients and to the faithful committee! We are proud of young Saxons' accomplishments!

Also, congratulations to also to Mr. and Mrs. Art Spack on the recent birth of their new son.

Tony Rothbrust announced the committee for the August 4th "Friendship Meeting", of which Retirees are encouraged to bring a friend. The committee is as follows: Frank Diehl, Al Linder, Hazel Tibball, Evelyn Yuhnick and George Spack. Katy Lederle will be taking reservations for the event. Members will have to pay in advance for the September catered dinner in August when reservations are made.

George Spack, Tony Rothbrust and Bill Hiltbrand entertained the group with humorous stories.

The meeting was closed with *The Lord's Prayer*. Those who wished to stay to conclude the afternoon fellowship enjoyed a game of Bingo.

It has been brought to my attention that I have never printed

my new address here at Essex I, though I do still receive mail at my home address. Here is the address: Sue Fritzman, Essex I- Rm 7-- 2511 Bentley Dr., Salem, OH 44460. Once again thank you for the correspondence, it is so nice to hear from everyone!

I recently received a beautiful rainbow card from Tom and Ruthie Zakel of Branch 1, Cleveland, who have become faithful pen-pals. They wrote about the asparagus I had mentioned in my last article and said they found a patch of wild asparagus in a wooded area, which they visited frequently until it became sparse. I never knew asparagus grew wild and I had another one of my granddaughters Laurie looked up some information for me. It didn't go into much detail about the wild asparagus, but did say it called "Bath" asparagus. The article also mentioned white asparagus or "Spargel", which is cultivated without light. This asparagus is less bitter than the green variety and is very popular in Germany and France. I remember my mother speaking of this type, but we never ate it, maybe it was for the rich for we didn't consider it a common vegetable. There is also a purple asparagus, which is high in sugar and low in fiber and originated in Italy. This pricey vegetable thrives in soils that are too saline for normal weeds to grow in, which can be a disadvantage for other crops cannot grow there. Tomatoes are a good companion plant for asparagus for the tomato plant repels beetles, while the asparagus repels some harmful root nematodes that affect tomato plants.

I also learned that asparagus was cultivated by the ancient Romans in special greenhouses and was used for medicinal purposes as well as a vegetable. It is related to the lily and is still recognized for its medicinal properties. Asparagus is low in calories and is very low in sodium and the green especially is a good source of antioxidants and other important vitamins and essential nutrients. It is also a diuretic and contains substances that protect our small blood vessels from rupturing. Asparagus can also be pickled and stored for several years and labeled as marinated in stores.

I was recently thinking about our overseas trip from the "old country" to Ellis Island and often wondered about the ship we came over on called "The Bremen". I had heard that on its voyage back to Germany it sunk and never really found any information about this and wondered about other such passenger ships and how many there are now. Once again, my granddaughter look this up on the Internet and found there were several ships named "The Bremen" for they were often named after their docks and variations of the name. Bremen

and Hamburg have been the two major docks in Germany for two centuries along with the Luebeck. I wonder if these ships are still used to bring foreigners to our country and how much it would cost compared to traveling by plane. I wouldn't know for I have never been a traveler.

There are now many who love to travel on these cruise ships for luxurious dream vacations with scheduled entertainment and wonderful food and relaxation. This reminds me of the terrible experience my niece Mari Ann of Michigan had with her late husband Jerry on a cruise ship vacation from the FLA harbor. They always loved to travel and were so excited about this venture as they dressed for a gala evening of ballroom dancing and dining. Mari Ann was ready to enter the dance floor for a graceful slow waltz with Jerry following as an obedient spouse. While they were enjoying the dance, Mari Ann suddenly felt a sharp kick on her leg and thinking it was her hubby, she of course gave him a dirty look. Jerry had lost his balance and both fell to the floor. As they looked around, somewhat disoriented, they realized others had also fallen along with everything around them: tables, chairs, food, glasses, etc. Soon there was an announcement from the captain that everyone should remain calm, that they had just experienced a little turbulence. While trying to protect themselves from falling objects and such, they held onto a nearby table and hid there for safety as the rocking motion went on for hours. Finally, it was calm enough to stand again, though still dangerous because of the slippery floors and debris. All of the other passengers who were also understandably very upset with the situation crowded towards the captain's office for complaints and a refund. This is one of those experiences that may be funny when you look back on them, but very frightening and not funny at all when it happens. I hope you enjoyed this memory Mari Ann. Are you ready to sign-up for another cruise?

While we are on the subject of funny stories that weren't so funny when they happened, I must share an experience Mike and I had while picking potatoes. We had a bright idea to get fresher potatoes from a potato farm, which was a big mistake. We took our red truck to a farm where you could drive your truck as you picked and had enough picking after two very long rows. When we were ready to head for home, for some reason, our truck started, but wouldn't move. Mike got out and looked to see what the problem was and discovered that while driving thru the rows the dried vines and weeds had wrapped tightly around our wheels locking everything up. We were very worried, for no one was around and it was getting dark. This was before the cell phone days, of course, so we were stranded with no way

Homeowners look to the attic for new remodeling space

Remodeling a home can provide more living area without building on extra rooms. Now that the economy is moving in the right direction, more homeowners are investing in revamping existing space in the attic, basement, porch or garage.

The attic is a popular destination for a new bedroom. But homeowners are also using attic space for an office, exercise room, movie screening room, a spa or as a private getaway for meditation.

Empty nesters are remodeling too, but they are not looking for more space. They just want it reconfigured.

People with adult kids or retired parents living with them have a need for more privacy. According to a recent survey by AARP, a full third of respondents ages 18 to 49 reported living or having lived with parents or in-laws.

With a still iffy real estate market, homeowners are deciding to take advantage of the 400 or 500 square feet they can find in the home they have.

Attic conversions can be tricky. They can include building stairs, reinforcing the floor so it can hold fur-

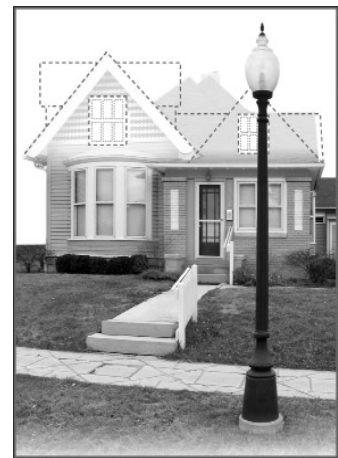

niture, adding a window or two and routing wires, ducts and pipes.

A survey last year by the Home Improvement Institute showed that one in five remodelers planned to focus on the attic in 2010. The industry hopes attic conversions will provide a much-needed \$225 billion boost in sales, according to Smart Money magazine.

One industry survey shows that 83 percent of attic remodeling costs can be recouped when the house is sold.

During the housing boom, high-visibility rooms like kitchens, master suites and family-room expansions were popular among remodelers.

Now, homeowners are looking for space to put a grown kid or a parent.

of contacting anyone. Thank God a farmer finally came along and spotted us and gave us a ride home and we went back the next day to get the truck. Once again, a story that seems funny now, but at the time was not funny at all.

Our bad luck with potatoes continues, though when we then decided to plant our own potatoes. This idea didn't last long, for we sadly hit two baby bunny nests and were devastated and felt so bad. From then on we gave up on all these potato ideas and went back to buying them at the store. I do miss those gardening days, though!

I was surprised as many others were to read in our local paper that a Ravenna couple named Lyons purchased the old Prospect Elementary School built in 1896 and has been vacant since 2007. The surprising part is that they want to live in it and have no plans to tear it down. This is not the typical one-story schoolhouse of which have been commonly renovated into homes. This is a three level 27,700 square foot building. Mr. Lyons was a former student at the school and paid only \$10,000, but it cost \$30 to \$40,000 to maintain, which is why the school board so readily

approved the sale.

Here it is, half of 2010 over already as we celebrate another of our country's important holidays. When my father applied for his citizenship into the U.S.A. they asked the important question, "Why do we celebrate the 4th of July in the U.S.A.?" My father answered the best he could with his newly learned English language "We got loose from England!" That says it all! How many Americans know that today?

It is upsetting to see how many of our American products are made in other countries, especially in China. There is no good reason we can't make these common plastic and other items here. It is even more upsetting to see our American Flag and other novelty patriotic products that are not made in the U.S.A. What an insult to our country. Surely they may be cheaper, but please support our country and buy American. Our pride should be worth more than the price difference of these copies. We are American with pride in our fine country! Hope you enjoyed your Independence Day Celebration and the rest of the summer!

Auf Wiedersehen!

PotPourri

Storybook word search

M C H O O P E T E R P A N
 D O O H N I B O R V Y B A
 H C W D D X T E H P T L N
 B A H G W U E A M I O O N
 A A P E L M M U B U Y S Y
 L X M P S I L B I G E T Y
 O F A B Y H A E O P P B T
 O L R M I R I O D E O O S
 J O T L E Y F R R G D Y U
 O R F T C Y P D E O A S R
 C A I X I Y I E Q C O R T
 K H K E L T P W E N A W E
 W A I M A R I E L L P T L
 S S N E E Z Y Y A O S Q G
 T I G G E R G I D E O N I
 Y E U H A I E E Y O R E P

ALICE	LUMPY
BALOO	MARIE
BAMBI	MOWGLI
CHESHIRE CAT	NANNY
DEWEY	OWL
DOC	PEG
DOPEY	PERDITA
DUMBO	PETER PAN
EDGAR	PIGLET
EYDOR	PLUTO
FLORA	POOH
GIDEON	ROBIN HOOD
GOOFY	ROO
HAPPY	SLEEPY
HUEY	SMEE
JOCK	SNEEZY
KANGA	TIGGER
KING	TRAMP
LADY	TRUSTY
LOST BOYS	WHITE RABBIT
LOUIE	

Ribs on the grill are a summer tradition

Rib wars have existed in the United States and throughout the world since the recorded annals of civilized man, or at least partially civilized man.

Rib meat and rib sauce competitions are prolific. From the Carolinas in the East to deep in the heart of Texas, recipes for ribs and liquid basting sauces abound.

Many East Coast sauce recipes are vinegar-based, like the North Carolina sauces. Texas concoctions are sweeter and contain more tomato sauce. Ribs usually have a chili powder base with herbs. They often have smoke flavorings.

Here is a simple sauce that can be made ahead and stored in the refrigerator. This recipe makes about one quart. It's in the North Carolina sauce category and can be used either as an

over-night marinade or for basting after the meat is placed on the grill.

Simple rib sauce

3 cups brown sugar
 3 cups white vinegar
 10 dashes salt
 10 grinds pepper
 2 dashes Worcestershire sauce
 20 dashes Louisiana hot sauce

Mix all ingredients thoroughly in a medium-size bowl. Ladle or brush sauce over the ribs while grilling. Allow the sauce to caramelize.

The ribs may be baked for about an hour, constantly basting with the sauce. Then turn the oven to the broil position for finishing. Carefully watch the meat until the sauce caramelizes and hardens on the top but don't let it burn or become too blackened.



'What's up, Doc?' crossword

- Across
- Thwack
 - Kind of rule
 - Chinese dollar
 - "The Last of the Mohicans" girl
 - Descartes's "therefore"
 - "That hurt!"
 - Seeds used in cooking
 - "Chicago" lyricist
 - Demagnetize
 - Opera star
 - Fly in the ointment
 - Squirrel's nest
 - ___ sandwich
 - Big ___ Conference
 - Ottoman governor

- Down
- "See ya!"
 - Couple's pronoun
 - Summon by beeper
 - Pout
 - Tolkien creatures
 - "___, humbug!"
 - Corsage

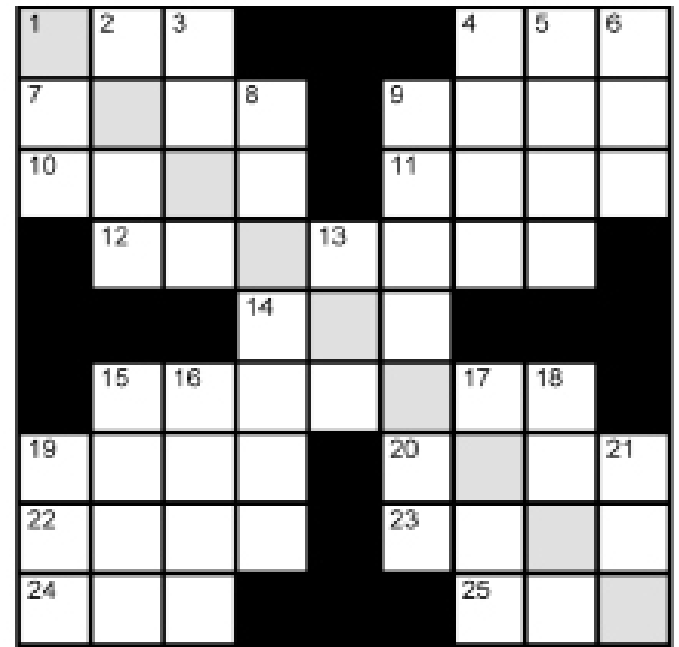

- Burn
- Attorneys' org.
- Acute
- All square
- Give the cold shoulder
- Not crazy
- "Silent Spring" subject
- In high spirits

The title is a clue to the word in the diagonal.

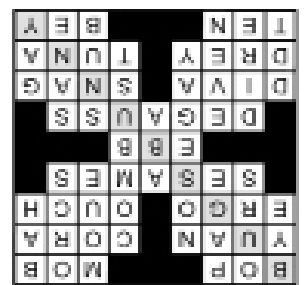

\$\$\$\$\$\$ Moneywise

Save a few bucks on groceries

It takes time to study the Sunday newspaper insert and clip money-saving coupons, especially since most are for products you never buy. Here's a better way. Make your grocery list, including pet foods and housekeeping supplies.

Go to the Internet and call up the foods and supplies on your list. There's a good chance that a coupon is available for you to print out.

When you find a coupon that interests you, check the net price against the store brand. It could turn out to be less.

Why not save \$4 or \$5 on groceries, supplies and pet food? It adds up.

\$1 movie rentals

Renting a movie from Redbox costs less than renting from a video store, just \$1 for an over-night rental. But customers don't have the pleasure of browsing and examining DVD information before renting as they do in a video store.

There are about 22,400 Redbox kiosks in the United States. They are in every sort of store and even in parking lots.

Redbox has agreed with movie makers to wait 28 days before renting new DVD releases. The first 28 days after a new release is the period when 90 percent of new DVD sales occur.

Netflix has agreed to the same 28-day waiting period after a DVD release before they offer it to their customers.

July 24: National Day of the Cowboy

It was a tough and lonely job, but the historic American cowboy endured it with courage and a song. Using and modifying traditions passed on from Mexican vaqueros and the Spanish before them, the cowboys became a basic part of American Western heritage and legend.

On the National Day of the Cowboy, we celebrate their contributions to the pioneering spirit of America.

As the cities of the American East and Midwest grew in the mid-to-late 1800s, the need for food, especially for meat, grew along with it. Then the great roundups and cattle drives became a part of our Western heritage. The cowboys worked long days and nights tending their herds despite dangers from terrain they had to cross, unhappy Indians and fierce outlaws whose goal was to steal the herds.

As the railroads developed, the need for long cattle drives

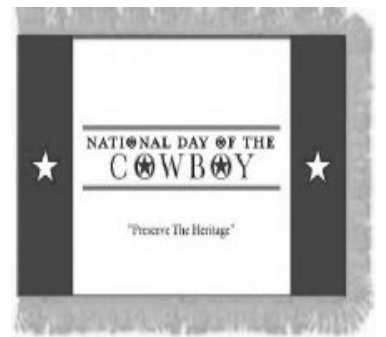

decreased. Over time, the cowboy techniques of riding and cattle-handling became the focus of today's rodeos.

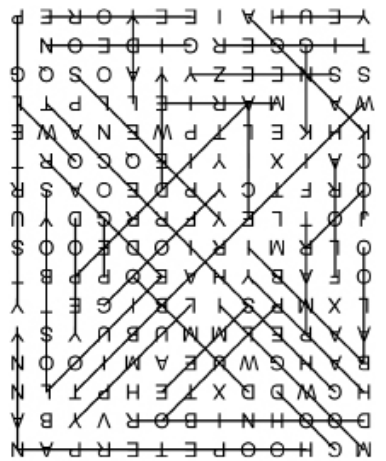

See American goldfinches by your own window

If you long to see a bright yellow and black goldfinch, getting one or more to visit your backyard feeder is not that difficult. All you need is a bag of thistle seed.

The males are yellow with black trim and the females are an olive-yellow. Watch for them.

The adult birds put on a show as they gather seed from thistle and zinnias, cosmos, bee balm, liatris and coreopsis.

Goldfinches love thistle seed, also known as nyjer, and sunflower seeds. Seed makes up almost their entire diet. They will regularly visit backyard feed-

ers and appreciate having a birdbath close by. Backyard birders see them across most of the United States and southern Canada.

They are among the latest nesting birds. In late summer, they collect thistle down to line their nests and raise four to six young, feeding them a partially digested substance called "canary milk." Both the male and female feed the baby birds.

Goldfinches may sing "per-chick-o-ree" with each flap of their wings as they fly. In winter, they may sing "se-mee, se-mee" and other pretty twittering songs.



ATS BRANCH DIRECTORY

Cleveland, OH Br. 1

Mtg. 3rd Mon. 7:00 p.m.
Sachsenheim 7001 Denison Ave.
(216) 651-0888
PRES. Adolf Fischer
4567 Williamston Ave. Brooklyn, 44144
(216) 741-1398
SEC'Y. Robert Cunningham III
9005 Memphis Villas, Brooklyn, 44144
(216) 398-7520
rbcunningham@roadrunner.com
ATS SEC'Y. R. Cunningham
LOCAL DUES to R. Cunningham

Erie, PA Br. 2

Mtg. 2nd Tues. 2:30 p.m.
Siebenbürger Hall 2114 French St.
(814) 452-4712
PRES. Thomas J. Manning
1027 W. 30th St. Erie, 16508
(814) 864-6072 etmann1@verizon.net
SEC'Y. Leona K. Wolfe
918 East 30th St. Erie, 16504
(814) 456-9982
ATS SEC'y. Judith Wagner
8663 W. Edinboro Rd. McKean, 16426
(814) 476-1188
LOCAL DUES to Vincenzo Leone
3417 Pacific Ave Erie PA 16506
(814) 838-3310

Alliance, OH Br. 3

Mtg. 3rd. Wed. - 6:30 p.m.
William Penn Club 1361 S. Webb Ave.
Correspondence to Matt Zeedrich
PRESIDENT John H. Aeling
15590 Georgetown St. NE Minerva, 44657
(330) 862-3706 JDAll852@yahoo.com
SEC'Y. Matt Zeedrich
16373 Freed St. SE Minerva, 44657
(330) 868-4650
ATS SEC'Y. Denise Aeling Crawford
15970 Cenfield St. Alliance, 44601
(330) 821-5125 dcrawfordcpa@yahoo.com
SICK NOTICES & LOCAL DUES to
Vincent Pisanello
605 Bonnieview, Alliance, 44601
(330) 823-1062

Cleveland, OH Br. 4

Mtg. 3rd. Mon. 7:00 p.m.
Sachsenheim 7001 Denison Ave.
(216) 651-0888
PRES. Monica M. Weber
19625 Riverwood Ave. Rocky River, 44116
(440) 356-5936
SEC'Y. Joan A. Miller-Malue
17105 Hilliard Rd. Lakewood, 44107
(216) 251-6036
ATS SEC'Y. Rosemarie Zimmer
9996 Lynn Dr. N. Royalton, OH 44133
(440) 237-7549
SICK NOTICES to Joan A. Miller-Malue
LOCAL DUES to Rosemarie Zimmer

Lorain, OH Br. 5

Mtg. 1st Sat. 8:00 p.m.
American Slovak Club
2915 Broadway, Lorain
PRES. George H. Schneider
1214 W. 26th St. Lorain, 44052
(440) 346-3199
SEC'Y. Jerome Powell
2308 Mark Dr. Lorain, 44052
(440) 282-4725
ATS SEC'Y. Elmer Schneider
226 Iowa Ave. Lorain, 44052
(440) 288-4014
SICK NOTICES to Ned A. Jones
2817 Utica Ave. Lorain, 44052
(440) 282-2796
LOCAL DUES to Andrew H. Schuffert
1704 N. Urban Circle, Lorain, 44053
(440) 282-2385

Farrell, PA Br. 7

Mtg. 3rd. Mon. 7:00 p.m.
Farrell Lions Den 810 Lions Club Lane
(724) 342-3218
PRES. Bertha Chec
941 Sharon-New Castle Rd., #121
Farrell, 16121 (724) 342-3139
SEC'Y. Betty Holmes
409 Patt Dr. Farrell, 16121
(724) 981-7130
ATS SEC'Y. Betty J. Krafft
774 McClure Ave. Sharon, 16146
(724) 347-7935
SICK NOTICES to Betha Chec

Alliance, OH Br. 8

Mgt. 3rd Wed. 6:30 p.m.
William Penn 1361 Webb
PRES. Helen E. Aeling
15354 Georgetown St. NE Minerva, 44657
(330) 862-2563 HHA658@aol.com

Alliance, OH Br. 8 cont.

SEC'Y. Phyllis Biggs
1690 S Freedom Alliance, 44601
(330) 823-0681
ATS SEC'Y. Denise Aeling Crawford
15970 Cenfield St, Alliance, 44601
(330) 821-5125 dcrawfordcpa@yahoo.com
SICK NOTICES to Phyllis Biggs

Chicago, IL Br. 9

Mtg. 1st Mon. 8:00 p.m.
DANK Haus 4740 N. Western (2nd floor)
PRES. Hilde Mueller
1205 W. Sherwin Ave., Apt. 308
Chicago, 60626
(773) 973-0923 saxonprez@att.net
SEC'Y. Diethild Thut
923 E. Slayton Dr Palatine IL
(847) 934-6308
SICK NOTICES & LOCAL DUES to
Hildegard Schmidts
1824 N Dover Arlington Heights, 60004
(847) 818-3884

Columbus, OH Br. 10

Mtg. 3rd Mon. 1:00 p.m. all months
Germania Club 543 South Front St.
PRES. Richard Kautz
1259 Medford Rd. Columbus, 43209
(614) 235-7661 rkautz@wideopenwest.com
SEC'Y. Susanna Mueller
726 Preston Trls Pickerington OH 43147
(614) 837-2221 opiomi@aol.com
ATS SEC'Y. Hilda F. Kautz
1259 Medford Rd. Columbus, 43209
(614) 235-7661 rkautz@wideopenwest.com
LOCAL DUES to
Michael Lassel, 6390 Havens Rd
Blacklick, OH 43004 (614) 861-2134

Lorain, OH Br. 11

Mtg. 1st Sat. 8:00 p.m.
American Slovak Home
2915 Broadway Ave.
PRES. Jeanne Petty
3728 Ivanhoe Dr. Lorain, 44053
(440) 960-1696
SEC'Y. Monica Gilles
3520 Beavercrest Dr. #107 Lorain, 44053
(440) 989-8180 gillemo76@hotmail.com
ATS SEC'Y. Monica Gilles
SICK NOTICES to Jane Mowery
1024 Highland Park Blvd. Lorain 44052
(440) 246-3004
LOCAL DUES to Sharron Powell
2308 Mark Dr, Lorain 44052
(440) 282-4725

Canton, OH Br. 14

Mtg. 2nd Sun. 2:00 p.m.
German American Club
7921 Georgetown St., Louisville
PRES. Thomas J. Rowinsky
1656 Dunkeith Dr NW, Canton, 44708
(330) 478-9333
SICK NOTICES & LOCAL DUES to
John Krach
1131 31st St. NE, Canton 44714
(330) 455-6024

Canton, OH Br. 17

Mtg. 2nd Sun. 2:00 p.m.
German American Club
7921 Georgetown St., Louisville
PRES. Mary Rowinsky
1656 Dunkeith Dr. NW, Canton 44708
(330) 478-9333
SEC'Y. Jeanne Kirsch
2222 42nd St. NW, Canton 44709
(330) 492-2856
ATS SEC'Y. Helen Aeling
15354 Georgetown St. NE Minerva, 44657
(330) 862-2563 HHA658@aol.com
SICK NOTICES to Mary Rowinsky

Salem, OH Br. 18

Mtg. 2nd Mon. 7:30 p.m.
Saxon Club 1980 St. Rt. 9 Salem, 44460
(330) 222-1770
PRES. Marilyn McNutt
1721 State Route 9 Salem, 44460
(330) 337-8940 MMc4571877@aol.com
SEC'Y. Barbara Brayn
1389 Brookview Dr Salem, 44460
(330) 337-7487 babrayn@sbcglobal.net
ATS SEC'Y. Marcia Spack
1278 Stewart Rd. Salem, 44460
(330) 337-0250 marcia@sky-access.com
LOCAL DUES and
SICK NOTICES
to Katherine Oesch
669 E. Seventh St. Salem, 44460
(330) 332-8195
oesklo@sbcglobal.net

USE ONLY THIS FORM FOR CHANGE OF ADDRESS AND CANCELLATIONS

All information in the form
to the right and below must
be correctly typed, or leg-
ibly written.

- CHANGE
 CANCELLATION
 NEW to receive paper

THIS CHANGE IS FOR:

Branch No. _____ Certificate No. _____

SS# _____ Date of Birth _____

Name _____

Old Street Address was _____

City/State/Zip _____

New Street _____

City/State/Zip _____

HOME OFFICE RECORDS & VOLKSBLATT

VOLKSBLATT ONLY

Date: _____ Signature of Person Making Change _____

Mail to: Alliance of Transylvanian Saxons, 5393 Pearl Road, Cleveland, Ohio 44129-1597

Salem, OH Br. 19

Mtg. 1st Mon. 7:30 p.m.
Saxon Club 1980 State Route 9
Salem OH 44460
PRES. George Spack, Sr.
1372 W. State St. Salem, 44460
(330) 332-1442
SEC'Y. Robert P. Vogt, Sr.
973 Sunset Blvd. Salem, 44460
(330) 337-6357
rpv27@neo.rr.com
SICK NOTICES to Glenn T. Spack
943 Stewart Rd. Salem, 44460
(330) 332-8174
LOCAL DUES to Salem Saxon Club
c/o Richard Vogt, Sr.
1980 State Rt 9, Salem, 44460
(330) 332-9996

Youngstown, OH Br. 22

Mtg. 2nd Sun. 2:30 p.m.
Saxon Club Pavilion 710 S. Meridian 44509
(330) 792-7973
PRES. Bonnie J. Baker
4535 Mellinger Rd. Canfield, 44406
(330) 793-8691
SEC'Y. Marianne Sawicki
145 E. Ravenwood Youngstown, 44507
(330) 783-1292
ATS SEC'Y. Mary T. Stryffeler
52 S Dehoff Rd Youngstown, 44515
(330) 792-5773
SICK NOTICES to Marianne Sawicki
LOCAL DUES to Carmella Markel
12075 Sandy Ln N. Jackson OH 44451
(330) 538-2639

New Castle, PA Br. 25

Mtg. 1st Fri. 8:00 p.m.
Eintracht Hall 108 Taylor St.,
New Castle PA 16101 (724) 652-7221
PRES. Steve Kaplin
308 Edgewood St, N.Castle PA 16105
(724) 714-3842
SEC'Y. Daniel A. Both
1882 LaClair Dr., N. Castle PA 16101
(724) 658-9557 bothdan@comcast.net
ATS SEC'Y. Johann Paal
3201 State Rd N. Castle PA 16105
(724) 654-1776
SICK NOTICES to Daniel A. Both

Merrillville, IN Br. 26

Mtg. 1st Sun. 3:00 p.m.
Slovak Club - 6920 Broadway
(219) 756-5101
PRES. Jeff Szostek
1652 W. 97th Ave., Crown Pt., 46307
(219) 661-0233
REC. SEC'Y. Raymond (Sam) Palyok
724 E. 25th. Pl Lake Station, 46405
(219) 962-7345 Zands6@msn.com
ATS SEC'Y. Randall Floyd
1806 E. 73rd Ave. Merrillville, 46410
(219) 942-3494
SICK NOTICES to Raymond (Sam) Palyok

New Castle, PA Br. 27

Mtg. 1st Thurs. 8:00 p.m.
Eintracht Hall 108 Taylor St., 16101
(724) 652-7221
PRES. Edith Hartfelder
128 Decker Dr., N. Castle, 16105
(724) 652-5106 gac3h@comcast.net
SEC'Y. Marie Benedict
PO Box 25 Edinburg, 16116
(724) 667-7395 bckskinbny@verizon.net
ATS SEC'Y. Dolores J. LeComte
125 W North St Apt. 331
N. Castle, 16101
(724) 658-4110 deej65@yahoo.com

CHANGE OF ADDRESS FORM

New Castle, PA Br. 27 cont.

SICK NOTICES & LOCAL DUES to
Gertrude Tizak
241 Cambridge St. #406
N.Castle, 16105
(724) 652-1867

Monaca, PA Br. 29

Mtg. 1st. Sun. Saxon Club 410 6th St.
(724) 774-7737
PRES. Lawrence H. Crudden
1927 Hill Rd. Monaca, 15061
(724) 775-0260
SEC'Y. Sharon Donovan
405 McClain Rd Beaver Falls PA 15010
(724) 843-6801
ATS SEC'Y. Terri L. Munroe
1255 Chestnut St. Monaca, 15061
(724) 774-7094
SICK NOTICES to Sharon Donovan
Address as above
LOCAL DUES to Monaca Saxon Club
410 Sixth St Monaca PA 15061
Youngstown, OH Br. 30
Mtg. 2nd. Sun. 2:30 p.m.
Saxon Club 710 S. Meridian 44509
(330) 792-7973
PRES. Walter Benesch
1268 Bexley Youngstown, 44515
(330) 792-9357
SEC'Y. Richard Maurer
11157 Diehl Rd N. Jackson OH 44451
(330) 538-9811
ATS ADULT & JUV. SEC'Y. Roger Fotiuk
3849 Frederick Youngstown, 44515
(330) 792-0034
LOCAL DUES to Donald Hoelzel
695 E Western Reserve Unit 2601
Poland OH 44514
(330) 953-2856

Ellwood City, PA Br. 32

Mtg. 2nd. Wed. 7:30 p.m.
Saxon Club 901 Millview St.
(724) 758-3268
PRES. Docia Jacobs
130 Belton Rd. Ellwood City, 16117
(724) 758-8486 djeannej@yahoo.com
ATS Sec'y. Sara Mullin
600 Dover Ln. Ellwood City, 16117
(724) 758-4764

Cleveland, OH Br. 33

Mtg. 2nd. Weds. 7:30 p.m.
St. John's Lutheran Church
1000 Ford Rd Highland Heights OH
(440) 449-1334
PRES. George T. Schneider
1035 Pennfield Rd. Cleve Hts., 44121
(216) 382-8657 dpsgts@ameritech.net
SEC'Y. Jeffrey S. Krestel
5130 Kneale Dr. Lyndhurst, 44124
(440) 376-5223 Jfawes@hotmail.com
ATS SEC'Y. Dolf Litschel
8050 Conestoga Trail Concord, 44060
(440) 358-1184
SICK NOTICES to Jeffrey S. Krestel
LOCAL DUES to Michael N. Bretz
388 East 317th St. Willowick, 44095
440-943-4543

Cleveland, OH Br. 34

Mtg. 2nd. Weds. 7:30 p.m.
St. John's Lutheran Church
1000 Ford Rd Highland Heights OH
PRES. Ema Litschel
8050 Conestoga Trl. Concord Twp 44060
(440) 358-1184
SEC'Y. Arline Suts
413 Downing Dr. Chardon, 44024
(440) 285-9498 asuts@windstream.net
ATS SEC'Y. Martha Bretz
388 E 317th St. Willowick, 44095
(440) 943-4543
SICK NOTICES to Arline Suts
LOCAL DUES to Barbara Hum
33926 Roberts Rd. Eastlake 44095
(440) 942-5827

Detroit, MI Br. 37

Mtg. 1st. Sun. 3:00 p.m.
St. Peters Lutheran Church
11423 Chicago Rd. Warren, MI
(586) 979-3850
PRES. Susanna Fleischer
11060 Furbush Rd. Holly, 48442
(810) 694-1860
beetlebugsue7@peoplepc.com
SEC'Y. Janet Nelson
650 Trinway Dr. Troy, 48085
(248) 879-3213 janetreadnelson@juno.com
ATS SEC'Y. George Schemmel, Sr.
20843 Coventry Clinton Twp., 48035
(586) 791-8135
SICK NOTICES AND LOCAL DUES to
Samuel Fleischer
11060 Furbush Rd. Holly, 48442
(810) 694-1860
beetlebugsue7@peoplepc.com

Merrillville, IN Br. 40

Mtg. 1st. Sun. 3:00 p.m.
Slovak Club 6920 Broadway
PRES. Betty Mucha
6705 Harrison Ct. Merrillville, 46410
(219) 769-5539
SEC'Y. Brigitte Floyd
1806 E. 73rd Ave. Merrillville, 46410
(219) 942-3494 brigittefloyd@msn.com
ATS SEC'Y. Randall Floyd
1806 E 73rd Ave. Merrillville, 46410
(219) 942-3494 rfloyd1066@msn.com
SICK NOTICES to Brigitte Floyd
LOCAL DUES to Zita Palyok
724 E. 25th Pl. Lake Station, 46405
(219) 962-7345 zands6@msn.com

Ellwood City, PA Br. 45

Mtg. 2nd. Sun. 7:30 p.m.
Saxon Club 901 Millview Ave.
(724) 758-3268
PRES. John Squicquero
213 Wampum Ave. Ellwood City, 16117
(724) 758-8276
SEC'Y. Shane Wooley
607 Woodland Dr.
Zelienople PA 16063 (724) 462-1662
ATS SEC'Y. Sam Mullin
600 Dover Lane Ellwood City, 16117
(724) 758-4764
SICK NOTICES to Sam Mullin

INVITE your relatives and friends to
join the crowd at ATS.
Tell them about our fraternal society!

2010 SAXON HEIMATTAG COLORING CONTEST ARTISTS



PAIGE DELOY



BROOKE BEDNARZ



SAMANTHA PENZONE



ALEXANDER TEMPLE



SOFIA TERLESKY



EMMA GOELLNER



SARAH LOHSE



JOHNAH HRABOWY



SEBASTIAN TEMPLE



DAKOTA HRABOWY